

Martin®

Replacement Blades

FOR PRIMARY BELT CLEANERS

Clean Better
Last Longer
COST LESS

GUARANTEED!

100% money back guarantee



Blades for all models and manufacturers including:

- **Argonics™**
- **ASGCO®**
- **Flexco®**
- **ARCH**
- **Superior®**
- **American Eagle**
- **BENETECH®**

Martin® Replacement Blades

FOR PRIMARY BELT CLEANERS

Martin® High-Performance Urethane



Urethane	Color	Part Number Suffix	Durometer	Application Conditions	Temperature Range
Standard	Orange		85	Suitable for most applications, including abrasive conditions and exposure to solvents or oil. For use with materials such as coal, ore, bauxite, coke, refuse. Suitable for 80% or more of all applications.	-20° to 160°F (-30° to 70°C)
High Temperature	Green	GR	95	For use with high temperature materials such as clinker.	Continuous -40° to 300°F (-40° to 150°C) Intermittent 350°F (177°C)
Chemical Resistant	Brown	BR	90	Improved resistance to chemicals and reduces water absorption for high moisture environments such as limestone. Best choice for applications exposed to chemicals with pH as high as 11 and as low as 4.	-40° to 160°F (-40° to 70°C)
Low Rigidity	Tan	CL	86	For use with dry products such as sand and gravel. w	-20° to 160°F (-30° to 70°C)
Low Adhesion	Navy Blue	NB	90	For use with sticky or tacky products such as cement, glass, and wood chips.	-20° to 160°F (-30° to 70°C)

Martin® Urethane Blade Benefits:

- Manufactured in house for highest quality assurance
- Specially-formulated, color-coded urethane to suit any application
- Up to 54% more urethane in the wearable area than competitive blades
- High-performance urethane ensures product satisfaction
- Backed by our Absolutely, No Excuses Guarantee

**Clean Better
Last Longer
COST LESS
GUARANTEED!**

100% money back guarantee

We guarantee that our blades will fit and will **clean better, last longer, and cost less** than competitive blades.

Blade Design

BLADE PROFILE

Wear volume and attack angle contribute much more to blade life and cleaning performance than blade height.

CONSTANT ANGLE/AREA RADIAL PRESSURE (CARP) CLEANING

(A) To ensure consistent cleaning throughout all stages of blade life, our patented Constant Angle Radial Pressure ("CARP") technology incorporates a specially-designed curved blade. This constant angle design maintains efficiency throughout the service life of the blade.

(B) To prevent a reduction in blade-to-belt pressure, cleaner efficiency, and the constant need for retensioning, we combined our Constant Area Radial Pressure design ("CARP") with our tensioner technology to minimize the change in area throughout a blade's wear life.

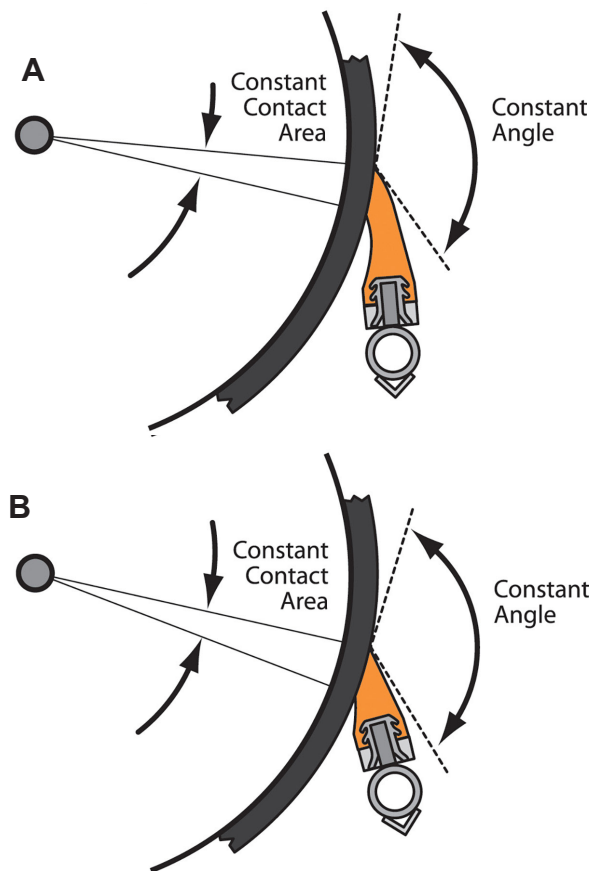

Material Path

For optimal cleaning and blade life, the blade width should be sized as close to the material path as possible.

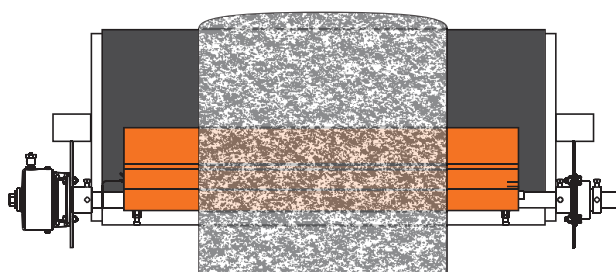

INCORRECT

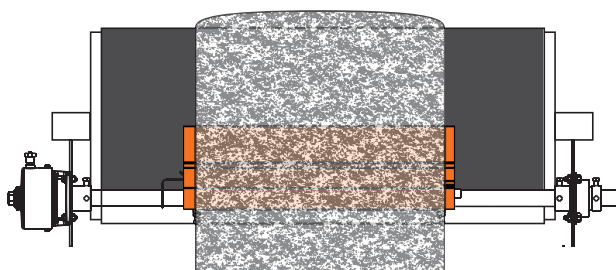

CORRECT

**Clean Better
Last Longer
COST LESS
GUARANTEED!**

100% money back guarantee

We guarantee that our blades will fit and will **clean better, last longer, and cost less** than competitive blades.

Martin® Replacement Blades FOR PRIMARY BELT CLEANERS

Argonics™ Eraser™ Primary Cleaner



SPECIFICATIONS

Description	Argonics™ Raptor™ Blade	Martin® Retrofit Blade for Eraser™ Primary Cleaner
Blade P/N	CP-RE-XX-G83	35794-XX
Usable Blade Volume per inch	5.6 in ³	6.53 in ³
Usable Blade Volume Increase		16%

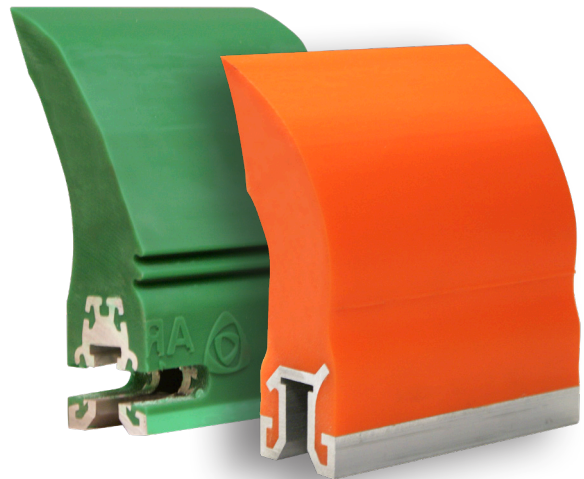

Belt Width in.	Blade Width in.	Argonics™ Raptor™ Blade P/N	Martin® Retrofit Blade P/N
18	12	CP-RE-12-G83	35794-12
24	18	CP-RE-18-G83	35794-18
30	24	CP-RE-24-G83	35794-24
36	30	CP-RE-30-G83	35794-30
42	36	CP-RE-36-G83	35794-36
48	42	CP-RE-42-G83	35794-42
54	48	CP-RE-48-G83	35794-48
60	54	CP-RE-54-G83	35794-54
66	60	CP-RE-60-G83	35794-60
72	66	CP-RE-66-G83	35794-66
78	72	CP-RE-72-G83	35794-72
84	78	CP-RE-78-G83	35794-78
90	84	CP-RE-84-G83	35794-84
96	90	CP-RE-90-G83	35794-90

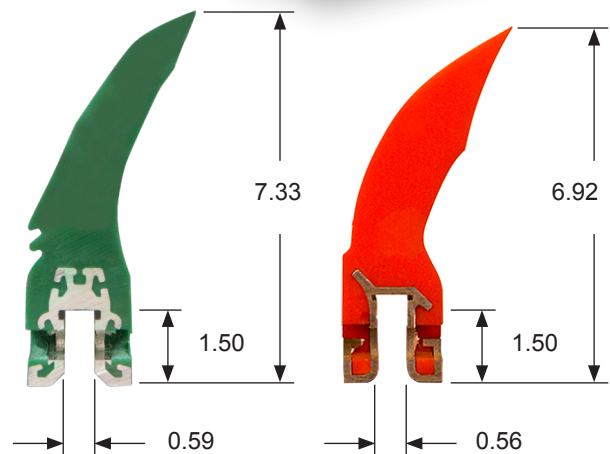

**Clean Better
Last Longer
COST LESS
GUARANTEED!**

100% money back guarantee

Argonics™, Eraser™, and Raptor™ are trademarks of Argonics Inc., Marquette, MI.

We guarantee that our blades will fit and will **clean better, last longer, and cost less** than competitive blades.

ASGCO® Skalper® Primary Cleaner

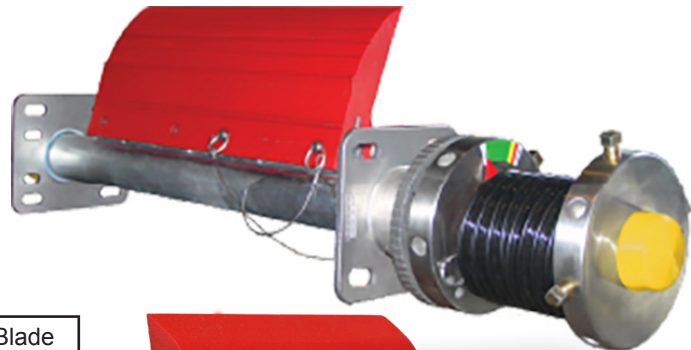

SPECIFICATIONS

Description	ASGCO® Skalper® Blade	Martin® Retrofit Blade for ASGCO® Skalper® Primary Cleaner
Blade P/N	ASG-SK4-XXA	36471-XX
Usable Blade Volume per inch	3.25 in ³	6.53 in ³
Usable Blade Volume Increase		53%



Belt Width in.	Blade Width in.	ASGCO® Skalper® Blade P/N	Martin® Retrofit Blade P/N
18	12	ASG-SK4-12A-1	36471-181112
24	18	ASG-SK4-18A-1	36471-241118
30	24	ASG-SK4-24A-1	36471-301124
36	30	ASG-SK4-30A-1	36471-361130
42	36	ASG-SK4-36A-1	36471-421136
48	42	ASG-SK4-42A-1	36471-481142
54	48	ASG-SK4-48A-1	36471-541148
60	54	ASG-SK4-54A-1	36471-601154
66	60	ASG-SK4-60A-1	36471-661160
72	66	ASG-SK4-66A-1	36471-721166
78	72	ASG-SK4-72A-1	36471-781172
84	78	ASG-SK4-78A-1	36471-841178
90	84	ASG-SK4-84A-1	36471-901184
96	90	ASG-SK4-90A-1	36471-961190

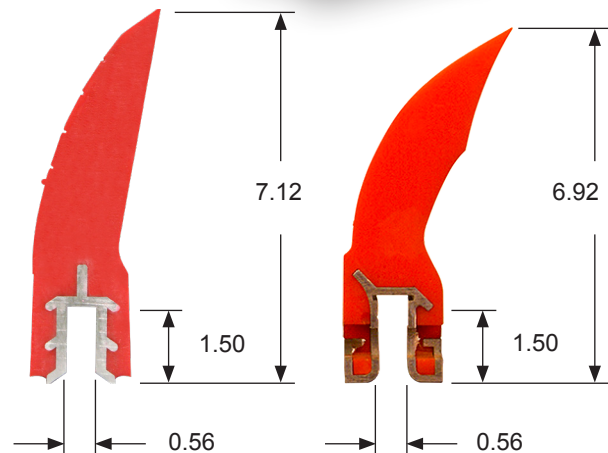

**Clean Better
Last Longer
COST LESS
GUARANTEED!**

100% money back guarantee

ASGCO® and Skalper® are registered trademarks of ASGCO Mfg, Inc., Allentown, PA.

We guarantee that our blades will fit and will **clean better, last longer, and cost less** than competitive blades.

Martin® Replacement Blades FOR PRIMARY BELT CLEANERS

Flexco® EZP1 Rockline® Primary Cleaner

SPECIFICATIONS

Description	Flexco® ConShear™ Primary Cleaner Blade	Martin® Retrofit Blade for Flexco® EZP1 Rockline® Primary Cleaner
Blade P/N	CRBXX	38108-XX11OR
Usable Blade Volume per inch	6.23 in ³	6.65 in ³
Usable Blade Volume Increase		7%



BLADE ORDERING INFORMATION

Belt Width in.	Blade Width in.	Flexco® ConShear™ Blade P/N	Martin® Retrofit Blade P/N
18	10	CRB10	38108-181110OR
24	16	CRB16	38108-241116OR
30	22	CRB22	38108-301122OR
36	28	CRB28	38108-361128OR
42	34	CRB34	38108-421134OR
48	40	CRB40	38108-481140OR
54	46	CRB46	38108-541146OR
60	52	CRB52	38108-601152OR
66	58	CRB58	38108-661158OR
72	64	CRB64	38108-721164OR
78	70	CRB70	38108-781170OR*

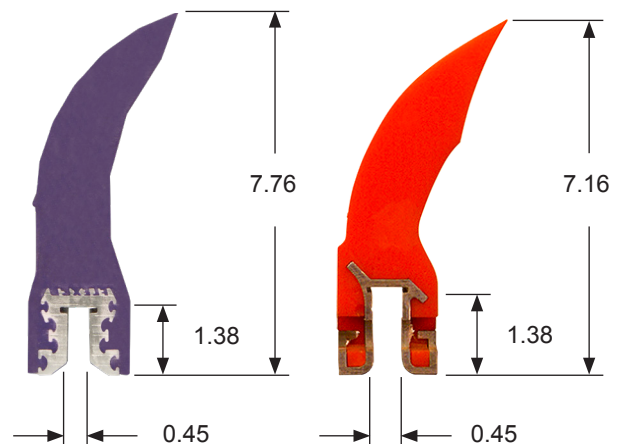

**Clean Better
Last Longer
COST LESS
GUARANTEED!**

100% money back guarantee

We guarantee that our blades will fit and will **clean better, last longer, and cost less** than competitive blades.

Flexco® and Rockline® are registered trademarks of Flexible Steel Lacing Company, Downers Grove, IL. ConShear™ is a trademark of Flexible Steel Lacing Company, Downers Grove, IL.

Flexco® MMP Primary Cleaner

SPECIFICATIONS

Description	Flexco® Tuffshear™ Primary Cleaner Blade	Martin® Retrofit Blade for Flexco® MMP Primary Cleaner
Blade P/N	TRBXX	39452-XX11
Usable Blade Volume per inch	11.8 in ³	11.8 in ³
Usable Blade Volume Increase	Equal	Equal

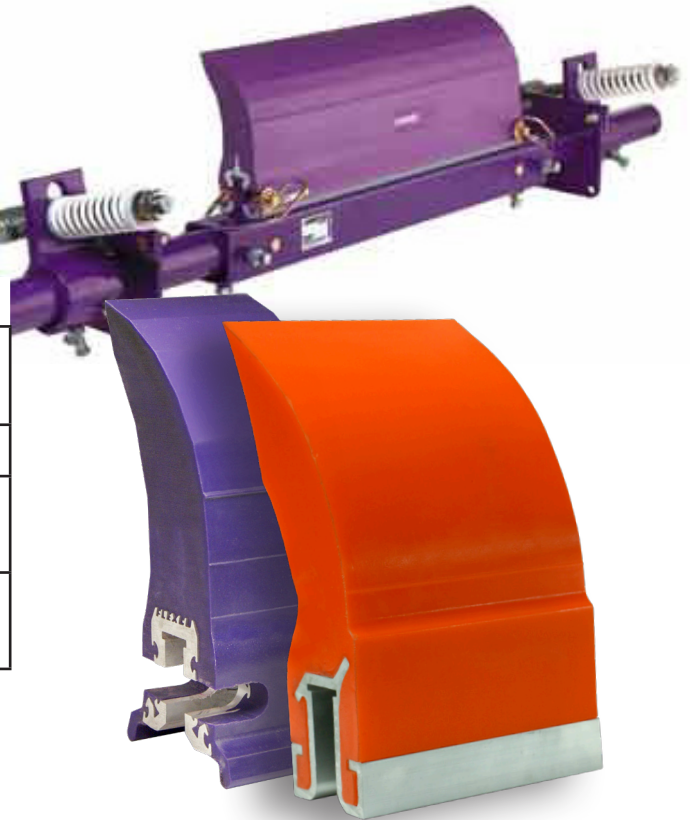

BLADE ORDERING INFORMATION

Belt Width in.	Blade Width in.	Flexco® TuffShear™ Blade P/N	Martin® Retrofit Blade P/N
24	18	TRB18	39452-2411
30	24	TRB24	39452-3011
36	30	TRB30	39452-3611
42	36	TRB36	39452-4211
48	42	TRB42	39452-4811
54	48	TRB48	39452-5411
60	54	TRB54	39452-6011
66	60	TRB60	39452-6611
72	66	TRB66	39452-7211
78	72	TRB72	39452-7811
84	78	TRB78	39452-8411
90	84	TRB84	39452-9011
96	90	TRB90	39452-9611

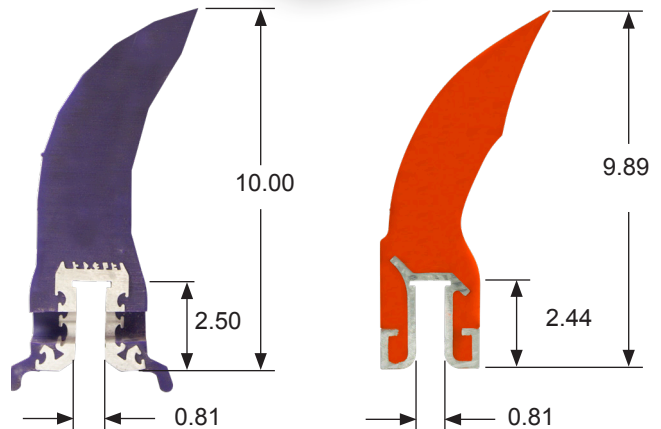

**Clean Better
Last Longer
COST LESS
GUARANTEED!**

100% money back guarantee

We guarantee that our blades will fit and will **clean better, last longer, and cost less** than competitive blades.

Flexco® is a registered trademark of Flexible Steel Lacing Company, Downers Grove, IL. TuffShear™ is a trademark of Flexible Steel Lacing Company, Downers Grove, IL.

Martin® Replacement Blades FOR PRIMARY BELT CLEANERS

ARCH Saber® (SB) Primary Cleaner



SPECIFICATIONS

Description	ARCH Saber® (SB) Blade	Martin® Retrofit Blade for ARCH Saber® (SB) Primary Cleaner
Blade P/N	SB-016-XX	34500-XX11
Usable Blade Volume per inch	3.06 in ³	4.13 in ³
Usable Blade Volume Increase		35%

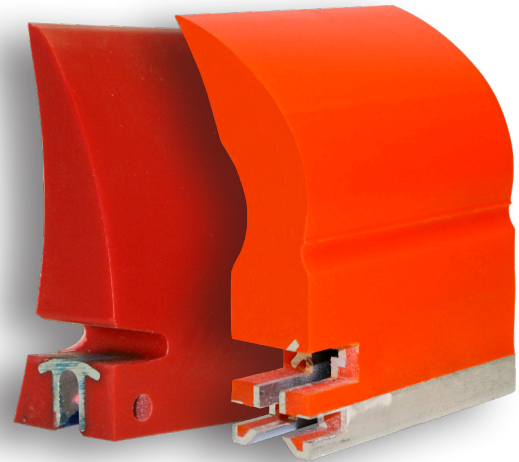

BLADE ORDERING INFORMATION

Belt Width in.	Blade Width in.	ARCH Saber® (SB) Blade P/N	Martin® Retrofit Blade P/N
18	16	SB-016-18	34500-1811
24	22	SB-016-24	34500-2411
30	28	SB-016-30	34500-3011
36	34	SB-016-36	34500-3611
42	40	SB-016-42	34500-4211
48	46	SB-016-48	34500-4811
54	52	SB-016-54	34500-5411
60	58	SB-016-60	34500-6011
66	64	SB-016-66	34500-6611
72	70	SB-016-72	34500-7211
84	82	SB-016-84	34500-8411
96	94	SB-016-96	34500-9611

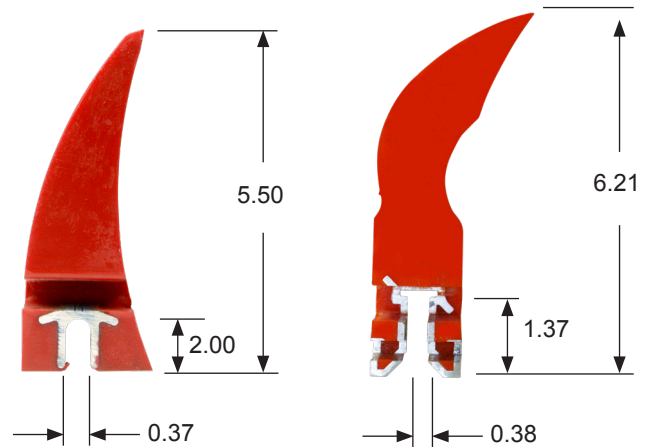

**Clean Better
Last Longer
COST LESS
GUARANTEED!**

100% money back guarantee

Saber® is a registered trademark of Arch Environmental Equipment Inc., Paducah, KY.

We guarantee that our blades will fit and will **clean better, last longer, and cost less** than competitive blades.

ARCH Saber® (SCM) Primary Cleaner



SPECIFICATIONS

Description	ARCH Saber® (SCM) Blade	Martin® Retrofit Blade for Arch Saber® (SCM) Primary Cleaner
Blade P/N	SCM-XX	35885-XX11
Usable Blade Volume per inch	3.06 in ³	4.13 in ³
Usable Blade Volume Increase		35%



BLADE ORDERING INFORMATION

Belt Width in.	Blade Width in.	ARCH Saber® (SCM) Blade P/N	Martin® Retrofit Blade P/N
18	16	SCM-18	35885-1811
24	22	SCM-24	35885-2411
30	28	SCM-30	35885-3011
36	34	SCM-36	35885-3611
42	40	SCM-42	35885-4211
48	46	SCM-48	35885-4811
54	52	SCM-54	35885-5411
60	58	SCM-60	35885-6011
66	64	SCM-66	35885-6611
72	70	SCM-72	35885-7211
84	82	SCM-84	35885-8411
96	94	SCM-96	35885-9611

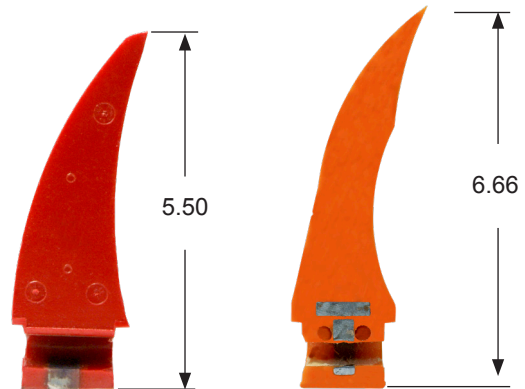

**Clean Better
Last Longer
COST LESS
GUARANTEED!**

100% money back guarantee

We guarantee that our blades will fit and will **clean better, last longer, and cost less** than competitive blades.

Martin® Replacement Blades FOR PRIMARY BELT CLEANERS

SUPERIOR Exterra® Primary Cleaner



SPECIFICATIONS

Description	Superior Exterra® Blade	Martin® Retrofit Blade for Superior Exterra® Primary Cleaner
Blade P/N	07-005XX	39291-STXX11XX
Usable Blade Volume per inch	5.0 in ³	6.53 in ³
Usable Blade Volume Increase		30%



BLADE ORDERING INFORMATION

Belt Width in.	Blade Width in.	Exterra® Blade P/N	Martin® Retrofit Blade P/N
18	16	07-00541	39291-ST181116
24	22	07-00542	39291-ST241122
30	28	07-00543	39291-ST301128
36	34	07-00544	39291-ST361134
42	40	07-00545	39291-ST421140
48	46	07-00546	39291-ST481146
54	52	07-00547	39291-ST541152
60	58	07-00548	39291-ST601158
66	64	07-00549	39291-ST661164
72	70	07-00550	39291-ST721170

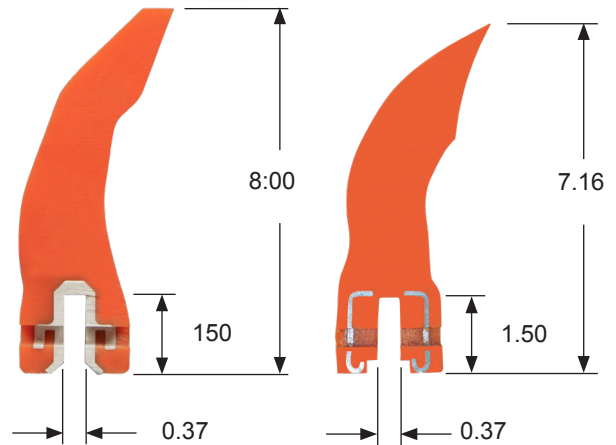

**Clean Better
Last Longer
COST LESS
GUARANTEED!**

100% money back guarantee

Exterra® is a registered trademark of Superior Industries Inc., Morris, MN.

We guarantee that our blades will fit and will **clean better, last longer, and cost less** than competitive blades.

BENETECH® BEP1 Primary Cleaner

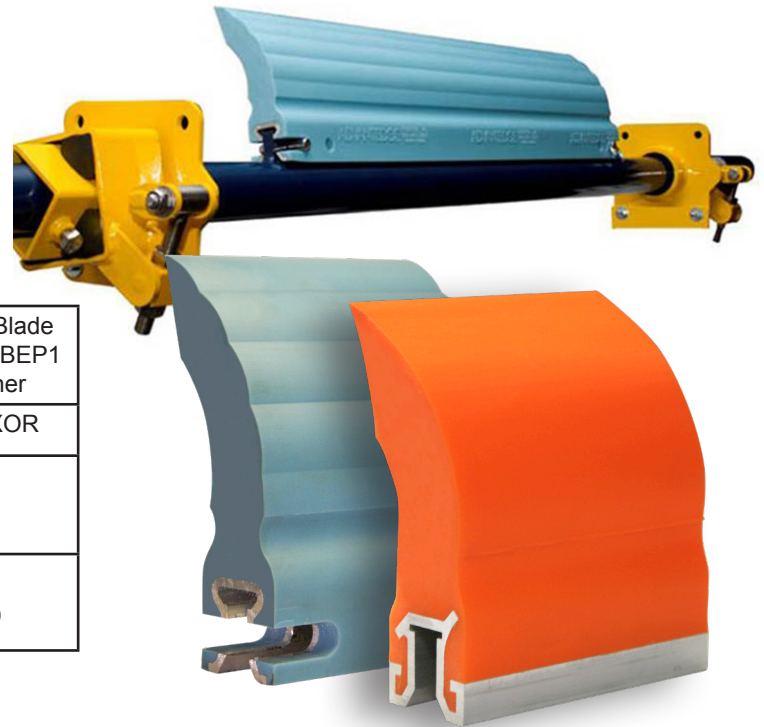

SPECIFICATIONS

Description	BENETECH® AdvantEdge™ Blade	Martin® Retrofit Blade for BENETECH® BEP1 Primary Cleaner
Blade P/N	BAPR1-0XX-0XX-1U1	39426-XX11XXOR
Usable Blade Volume per inch	5.6 in ³	6.53 in ³
Usable Blade Volume Increase		16%

BLADE ORDERING INFORMATION

Belt Width in.	Blade Width in.	BENETECH® AdvantEdge™ Blade P/N	Martin® Retrofit Blade P/N
18	16	BAPR1-018-1U1	39426-181116OR
24	22	BAPR1-024-1U1	39426-241122OR
30	28	BAPR1-030-1U1	39426-301128OR
36	34	BAPR1-036-1U1	39426-361134OR
42	40	BAPR1-042-1U1	39426-421140OR
48	46	BAPR1-048-1U1	39426-481146OR
54	52	BAPR1-054-1U1	39426-541152OR
60	58	BAPR1-060-1U1	39426-601158OR
66	64	BAPR1-066-1U1	39426-661164OR
72	70	BAPR1-072-1U1	39426-721170OR

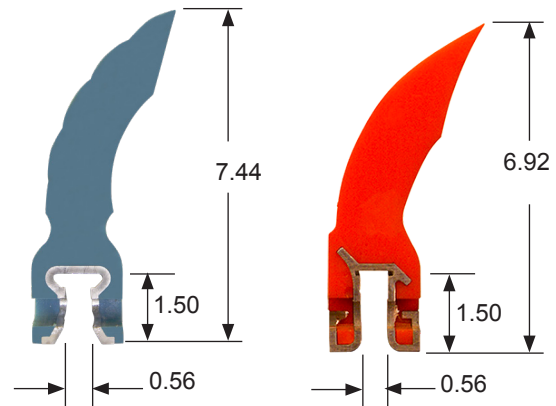

**Clean Better
Last Longer
COST LESS
GUARANTEED!**

100% money back guarantee

BENETECH® and AdvantEdge™ are registered trademarks of Benetech Inc., Aurora, IL.

We guarantee that our blades will fit and will **clean better, last longer, and cost less** than competitive blades.

Martin® Replacement Blades FOR PRIMARY BELT CLEANERS

American Eagle® E4 Series Primary Cleaner

SPECIFICATIONS

Description	American Eagle® E4 Blade	Martin® Retrofit Blade for American Eagle® E4 Primary Cleaner
Blade P/N	E4MXX	39425-XX11XXOR
Usable Blade Volume per inch	8.1 in ³	6.53 in ³
Usable Blade Volume Increase	24%	*

* Blades without CARP angle produce more surface area against the belt as they wear. This requires continually increasing pressure to maintain cleaning effectiveness and shortens blade wear life.

See CARP angle information on Page 3.

BLADE ORDERING INFORMATION

Belt Width in.	Blade Width in.	American Eagle E4 Blade P/N	Martin® Retrofit Blade P/N
18	16	E4M16	39425-181116OR
24	22	E4M22	39425-241122OR
30	28	E4M28	39425-301128OR
36	34	E4M34	39425-361134OR
42	40	E4M40	39425-421140OR
48	46	E4M46	39425-481146OR
54	52	E4M52	39425-541152OR
60	58	E4M68	39425-601158OR
72	70	E4M70	39425-721170OR

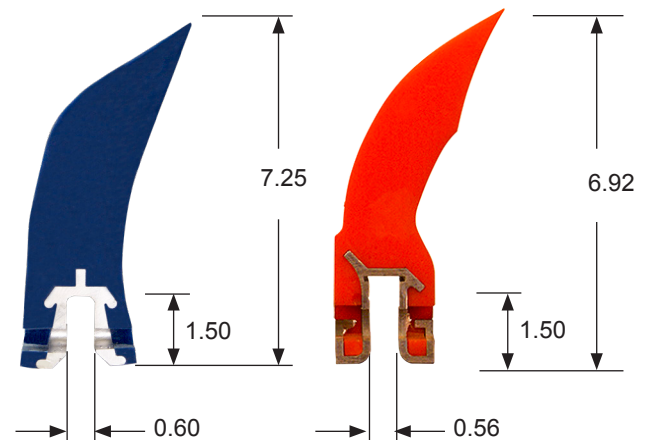
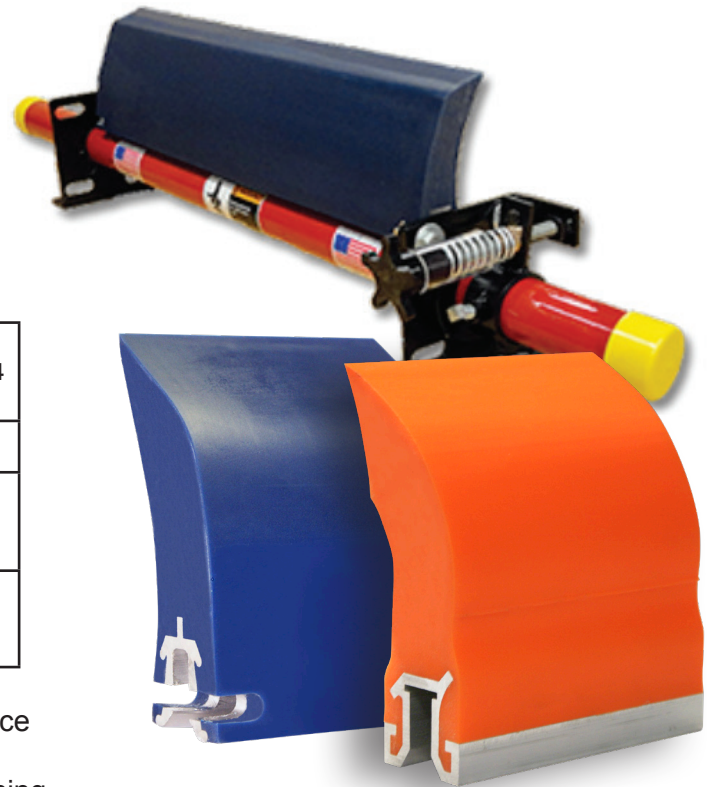

**Clean Better
Last Longer
COST LESS
GUARANTEED!**

100% money back guarantee

We guarantee that our blades will fit and **clean better**,
last longer, and **cost less** than competitive blades.

American Eagle® E5 Series Primary Cleaner

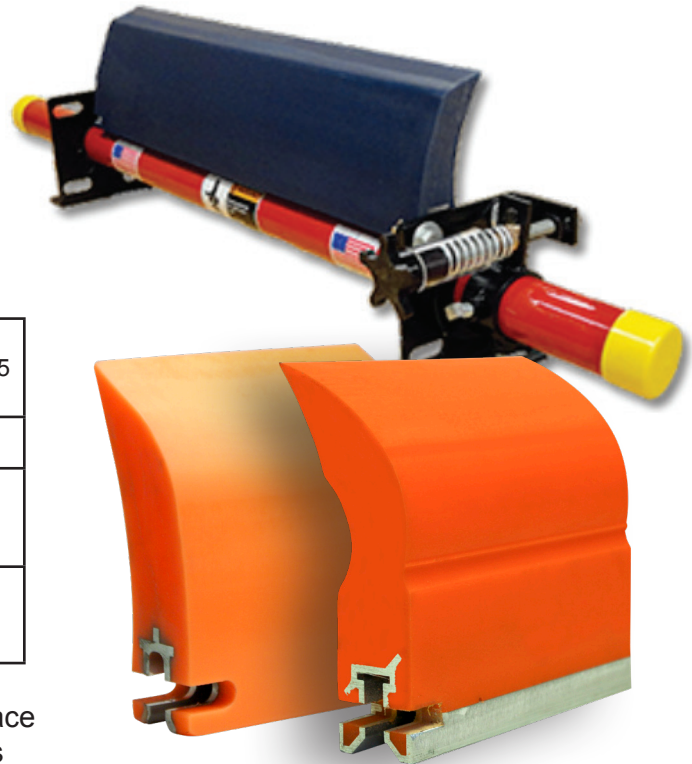

SPECIFICATIONS

Description	American Eagle® E5 Blade	Martin® Retrofit Blade for American Eagle® E5 Primary Cleaner
Blade P/N	E5MXX	39427-XX11XXOR
Usable Blade Volume per inch	5.3 in ³	4.13 in ³
Usable Blade Volume Increase	28%	*

* Blades without CARP angle produce more surface area against the belt as they wear. This requires continually increasing pressure to maintain cleaning effectiveness and shortens blade wear life.

See CARP angle information on Page 3.

BLADE ORDERING INFORMATION

Belt Width in.	Blade Width in.	American Eagle® E5 Blade P/N	Martin® Retrofit Blade P/N
18	16	E5M16	39427-181116OR
24	22	E5M22	39427-241122OR
30	28	E5M28	39427-301128OR
36	34	E5M34	39427-361134OR
42	40	E5M40	39427-421140OR
48	46	E5M46	39427-481146OR
54	52	E5M52	39427-541152OR
60	58	E5M58	39427-601158OR
72	70	E5M70	39427-721170OR

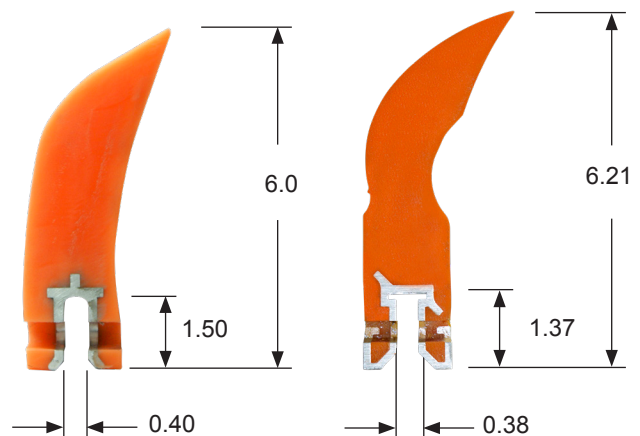

**Clean Better
Last Longer
COST LESS
GUARANTEED!**

100% money back guarantee

We guarantee that our blades will fit and will **clean better, last longer, and cost less** than competitive blades.

Martin® Replacement Blades FOR PRIMARY BELT CLEANERS

SPECIFYING YOUR MARTIN® RETROFIT BLADE

Retrofit Blade Part Number



Belt Width (inches) _____

Blade Width (inches) _____

Urethane Color _____

P/N PREFIX

35794: Argonics™ Eraser™

36471: ASGCO® Skalper®

38108: Flexco® EZP1 Rockline®

39452: Flexco® MMP

34500: ARCH Saber (SB)

35885: ARCH Saber® (SCM)

39291: Superior Exterra®

39427: American Eagle E5

39425: American Eagle E4

39426: BENETECH®

URETHANE COLOR

Ø or OR: Orange

GR: Green

BR: Brown

CL: Tan

NB: Navy Blue



**Clean Better
Last Longer
COST LESS
GUARANTEED!**

100% money back guarantee

We guarantee that our blades will fit and will **clean better, last longer, and cost less** than competitive blades.

PRECLEANER BLADE TROUBLESHOOTING GUIDE

Problem	Cause	Solution
Uneven Blade Wear - blade worn more in center than at ends	Incorrect blade length	Select blade width based on material path.
Rapid Blade Wear	Incorrect cleaner and/or blade	Select proper belt cleaner and blade based on belt width, belt speed, and head pulley diameter.
	Incorrect tension	Adjust tensioner according to applicable belt cleaner and/or tensioner operator's manual.
	Incorrect mounting	Verify correct mounting location according to applicable belt cleaner operator's manual.
Blade Flipping Through	Incorrect cleaner and/or blade	Select proper belt cleaner and blade based on belt width, belt speed, and head pulley diameter to ensure blade angle of attack is correct.
	Incorrect mounting	Verify correct mounting location according to applicable belt cleaner operator's manual.
	Incorrect tension (too low)	Adjust tensioner according to applicable belt cleaner and/or tensioner operator's manual.
Blade Chattering or Skipping on Belt	Belt is dry	Select proper urethane for dry material, such as Martin® Clear (CL) urethane.
Blade Urethane Melting	Belt is dry, friction causes heat to build up in blade	Select proper urethane for dry material, such as Martin® Clear (CL) urethane.
	Material being conveyed is exceeding temperature range of urethane	Select proper urethane for high temperature material, such as Martin® High-Temp (GR) urethane.



Clean Better
Last Longer
COST LESS
GUARANTEED!

100% money back guarantee

We guarantee that our blades will fit and will **clean better, last longer, and cost less** than competitive blades.

Martin® Replacement Blades FOR PRIMARY BELT CLEANERS

Clean Better
Last Longer
COST LESS
GUARANTEED!

100% money back guarantee

We guarantee that our blades will fit and will
clean better, last longer, and cost less
than competitive blades.

Up to
**53% MORE
BLADE
VOLUME**

Retrofit blades for competitive belt cleaners

ARGONICS Eraser™	pg. 4
ASGCO Skalper®	pg. 5
Flexco EZP1 Rockline® & MMP	pg. 6–7
ARCH Saber® (SB) (SCM)	pg. 8–9
SUPERIOR Exterra®	pg. 10
BENETECH® BEP1	pg. 11
American Eagle® E4 & E5	pg. 12–13

*For Richwood models please contact
your Martin Representative.*



MARTIN ENGINEERING USA
One Martin Place
Neponset, IL 61345-9766 USA
800-544-2947 or 309-852-2384
info@martin-eng.com
www.martin-eng.com

Problem Solved™ *GUARANTEED!*

Form No. L4047-06/19
© Martin Engineering Company 2016, 2019