

PART NUMBER	BELT WIDTH	DIMENSION "A" BLADE COVERAGE	DIMENSION "B" FRAME LENGTH
36898-18X12XX	18.00 [400-500]	12.00 [305]	44.00 [1119]
36898-18X16XX	18.00 [400-500]	16.00 [406]	44.00 [1119]
36898-24X18XX	24.00 [500-650]	18.00 [457]	50.00 [1270]
36898-24X22XX	24.00 [500-650]	22.00 [559]	50.00 [1270]
36898-30X24XX	30.00 [650-800]	24.00 [610]	62.00 [1575]
36898-30X28XX	30.00 [650-800]	28.00 [711]	62.00 [1575]
36898-36X30XX	36.00 [800-1000]	30.00 [762]	68.00 [1727]
36898-36X34XX	36.00 [800-1000]	34.00 [864]	68.00 [1727]
36898-42X36XX	42.00 [1000-1200]	36.00 [914]	74.00 [1880]
36898-42X40XX	42.00 [1000-1200]	40.00 [1016]	74.00 [1880]
36898-48X42XX	48.00 [1200-1400]	42.00 [1067]	80.00 [2032]
36898-48X46XX	48.00 [1200-1400]	46.00 [1168]	80.00 [2032]

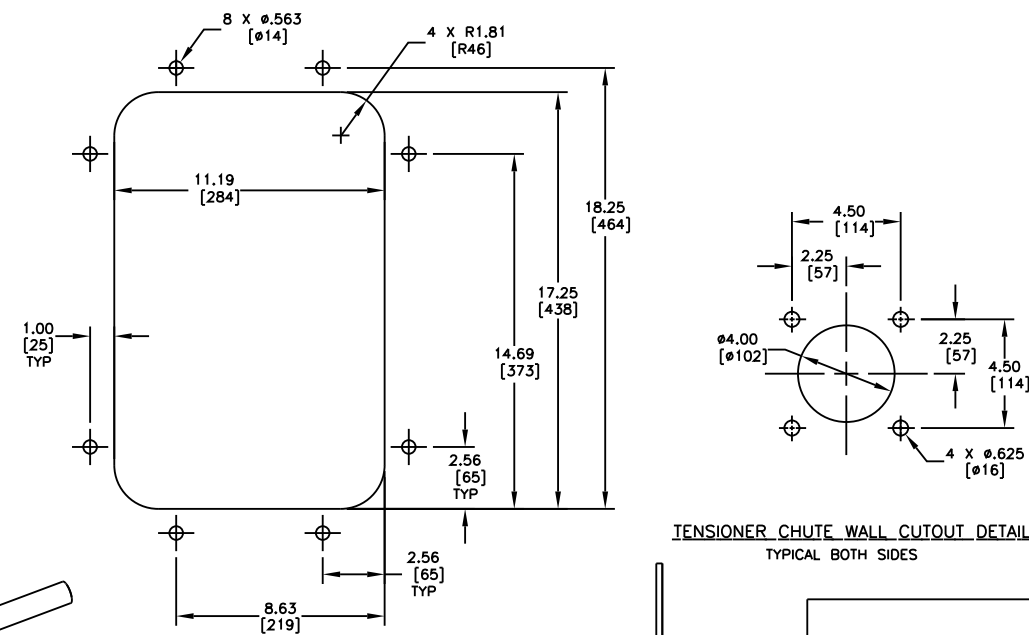

TENSIONER CHUTE WALL CUTOUT DETAIL
TYPICAL BOTH SIDES

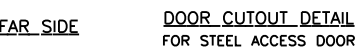

DOOR CUTOUT DETAIL
FOR STEEL ACCESS DOOR

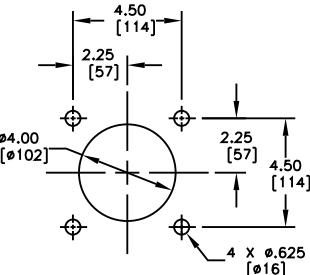

ITEM	QTY.	DESCRIPTION	PART NUMBER
1	1	MARTIN [®] QC [™] #1 HD BLADE MAINFRAME ASM	36898-XXXXX
2	1	MARTIN [®] TWIST [™] TENSIONER ASM	38850
3	1	MARTIN [®] ACCESS STEEL DOOR ASM	CYA-1218

- NOTES:
- 1) ALL DIMENSIONS ARE GIVEN IN INCHES (MM) AND ARE FOR REFERENCE ONLY.
 - 2) FRAME IS ADJUSTABLE TO DESIRED LENGTH.
 - 3) FIRST XX INDICATES BELT WIDTH. THIRD X INDICATES BLADE WITHOUT SLITS. FOURTH X INDICATES BLADE WITHOUT SEGMENTS. THE NEXT TWO XX'S INDICATE BLADE WIDTH. THE REMAINING X'S INDICATE BLADE COLOR.
EX: 36898-421036 = 42" BELT WITH 36" ORANGE BLADE W/O SLITS WITH SEGMENTS.
36898-421040GR = 42" BELT WITH 40" GREEN BLADE W/O SLITS WITH SEGMENTS.
36898-421136BR = 42" BELT WITH 36" BROWN BLADE W/O SLITS W/O SEGMENTS.
36898-421140 = 42" BELT WITH 40" ORANGE BLADE W/O SLITS OR SEGMENTS.
 - 4) FOR BELT WIDTHS 54.00 (1372) AND OVER, MARTIN[®] ENGINEERING RECOMMENDS USING A DUAL TWIST TENSIONER ASSEMBLY (P/N 38850-2). SEE S50090-D.
 - 5) WHERE EXTREME OR UNUSUAL CONDITIONS EXIST, OR SPECIAL MAINFRAME LENGTHS ARE REQUIRED, CONSULT MARTIN[®] ENGINEERING FOR ASSISTANCE.
 - 6) TWIST TENSIONER ASSEMBLY MAY BE BOLTED OR WELDED IN PLACE. MARTIN[®] ENGINEERING RECOMMENDS BOLTING WHEN APPLICABLE FOR EASIER MAINTENANCE AND ACCESSIBILITY. IF WELDING IS REQUIRED USE TWIST TENSIONER ASSEMBLY P/N 38850-A.
 - 7) REFER TO OPERATOR'S MANUALS (M3296 AND M3618) FOR INSTALLATION INSTRUCTIONS.
 - 8) MARTIN[®] ENGINEERING RECOMMENDS THE CLEANER BE LOCATED SO THAT THE BLADE TIP IS AT OR SLIGHTLY BELOW HORIZONTAL CENTERLINE OF HEAD PULLEY. CLEANER IS SHOWN BELOW IN RECOMMENDED WORKING POSITION.
 - 9) FOR SEVERE APPLICATIONS WELD MAINFRAME ADAPTER DIRECTLY TO MAINFRAME.
 - 10) THE QC[™]#1 HD PRE-CLEANER BLADE IS DESIGNED TO REMOVE INITIAL CARRYBACK ONLY. DO NOT OVER TENSION!
 - 11) THE QC[™]#1 HD PRE-CLEANER BLADE IS DESIGNED FOR HEAD PULLEYS WITH A MINIMUM EFFECTIVE DIAMETER OF 12.00 (305).

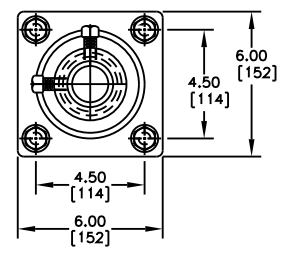

FAR SIDE MOUNT DETAIL

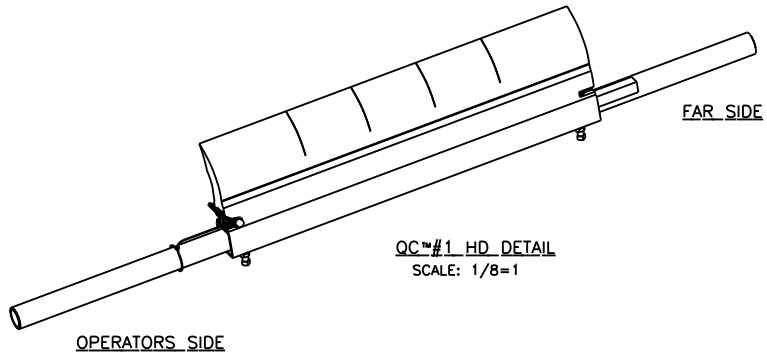

QC[™]#1 HD DETAIL
SCALE: 1/8=1

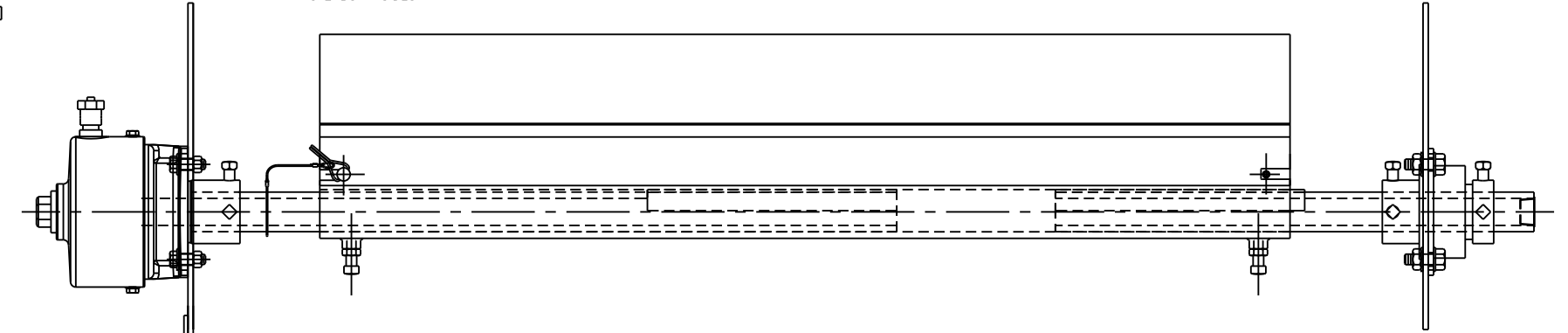

36898-481146XX SHOWN

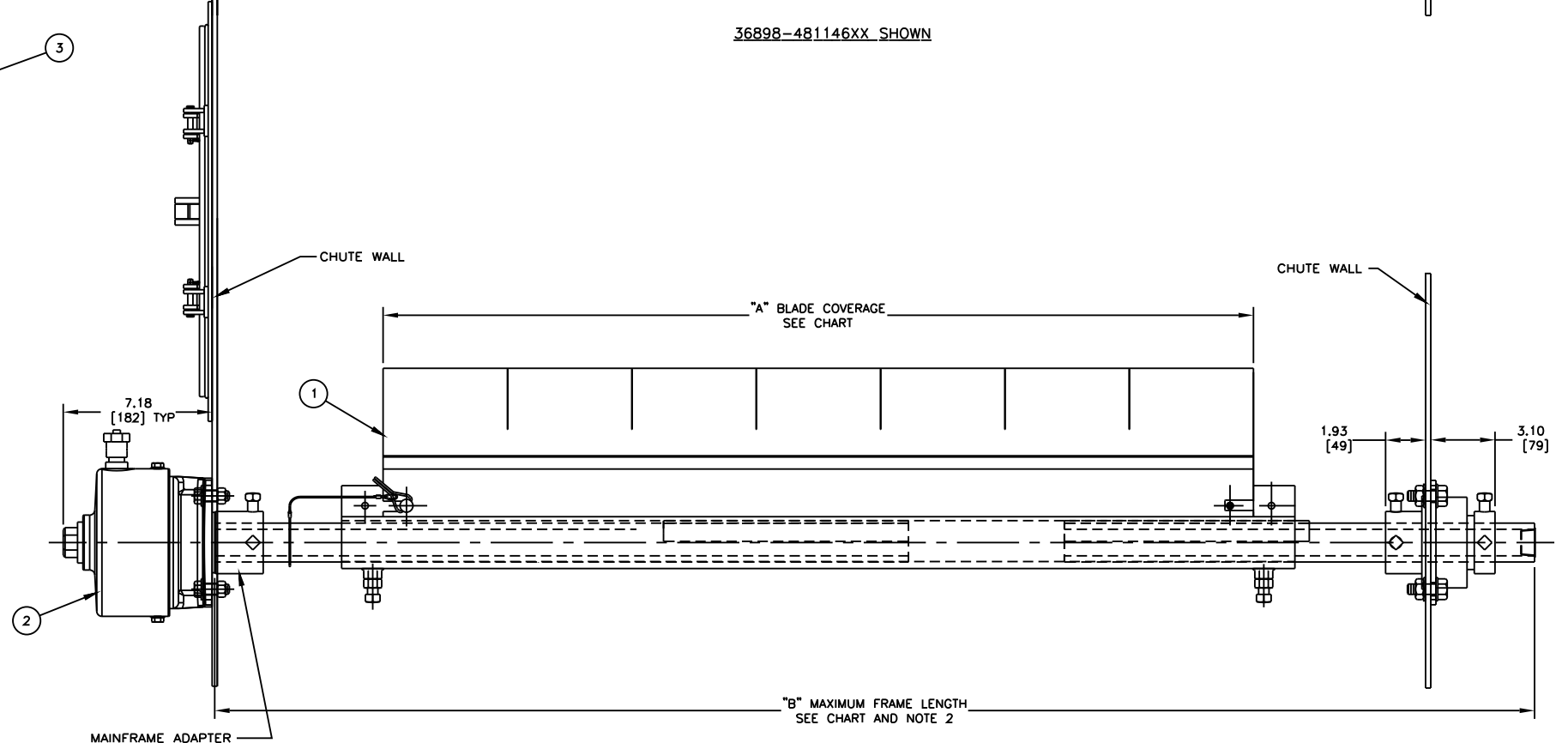
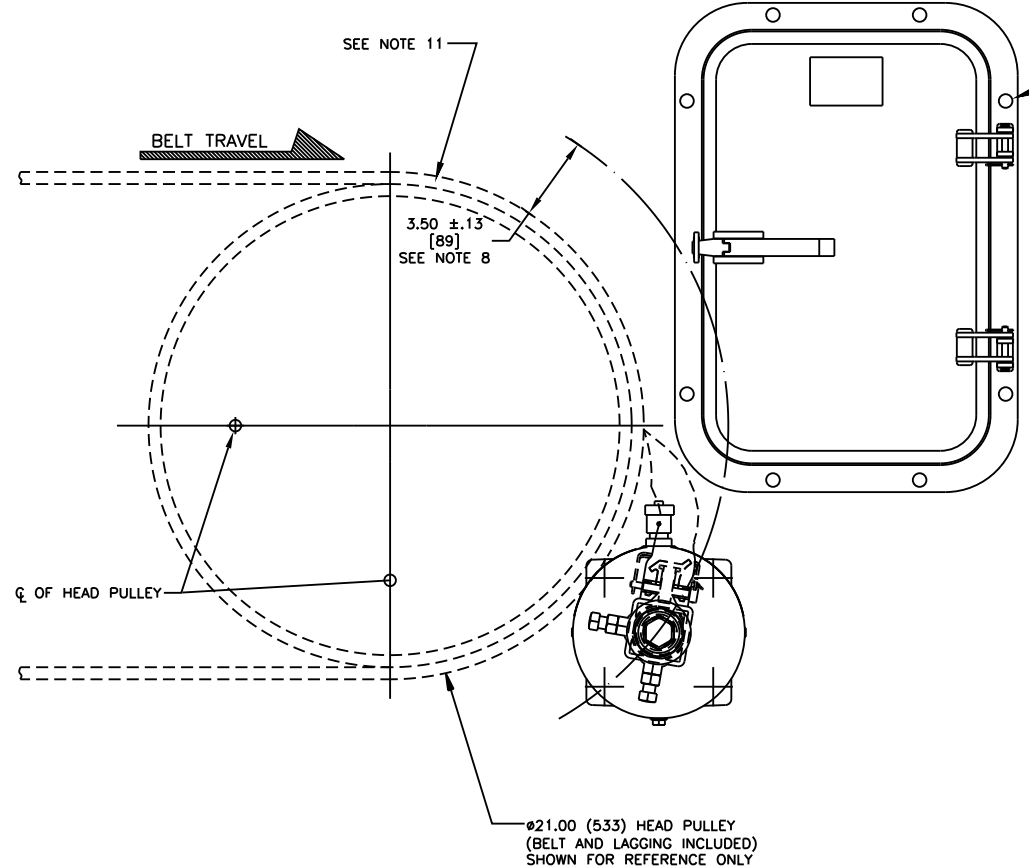

36898-481042XX SHOWN
HEAD PULLEY NOT SHOWN FOR CLARITY

© Copyright 2011 Martin Engineering. All rights reserved. Covered by U.S. and foreign patents pending and issued. ® and TM indicate trademarks of Martin Engineering.

MARTIN ENGINEERING
NEPONSET ILLINOIS USA

TITLE: MARTIN[®] QC[™]#1 HD ASM
MARTIN[®] TWIST[™] TENSIONER
12X18 STEEL ACCESS DOOR

NO. DESCRIPTION ECN DATE BY SALES DRAWING

AutoCAD REVISION

MD0825 S50090-S-1218

DRAWN JAH DATE 04/05/11
CHECKED
ENG. DATE 04/06/11
APPROVED DATE 04/06/11
SCALE 1/4=1

