



AIR CANNONS

POWERFUL, SAFE & EFFICIENT POWER
TO PUT MATERIALS IN MOTION

L3748EN





**CONSEQUENCES OF POOR
MATERIAL FLOW**

CHOKED PRODUCTION

REDUCED OUTPUT

STRANGLING EFFICIENCY

MISSING MATERIAL

INCREASED MAINTENANCE

MISSED OPPORTUNITIES

LOST PROFITS



SOLVING PROBLEMS IN MATERIAL FLOW



Hammering on the bin or chute wall leads to damage to the wall surface, often called "hammer rash."

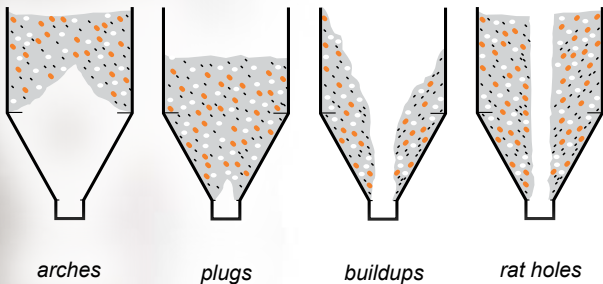

Problems in material flow can bring an operation's efficiency and productivity to a halt. Hang-ups in storage systems and accumulations in process vessels choke material flow while bottlenecks create costly reductions in equipment and process performance. Poor material flow raises maintenance expenses and drags profits down.

Martin® Air Cannons supply a quiet but powerful release of compressed air that dislodges buildups and enhances the flow of bulk materials, to improve efficiency and maintain profitability.

Since 1974, Martin® Air Cannons have been used around the world to prevent buildups and improve material flow. Martin Engineering remains the leader in the application of air cannon technology to overcome bottlenecks and boost the movement of material through high-capacity vessels.

Problem Solved™
GUARANTEED!



MARTIN® HURRICANE

MARTIN® HURRICANE AIR CANNON

Positive-acting, centrally-located valve design represents state-of-the-art engineering, with most direct air path, maximum force output, minimal air consumption, smallest footprint, and simplest installation.

- **Positive Action, High Output:** Maximum discharge strength from high velocity output with half the air volume, for highly effective discharge and reduced operating costs.
- **Improved Safety:** Discharge requires positive signal from solenoid, eliminating the risk of accidental firing.
- **Allows Longer Air Lines:** Positive-acting valve allows control solenoid to be positioned as far as 60 m from the tank, keeping solenoids away from harsh conditions and difficult service.



ONE-STEP MAINTENANCE

The design of the Martin® Hurricane Air Cannon allows for simple maintenance. The complete valve assembly can be removed in one easy step, working from one side of the tank.

It can be replaced within minutes to keep your process running. There is no need to ever remove the tank from the vessel for service.





MARTIN® TYPHOON

MARTIN® TYPHOON AIR CANNON

Hybrid design combines minimal one-line plumbing with compact, powerful, and efficient centrally-located valve.

TECHNOLOGICAL HYBRID

The hybrid design of the Martin® Typhoon Air Cannon offers an improvement on negative-pressure firing systems by combining the simple one-line plumbing of traditional valve design with the power, efficiency, and ease of maintenance of advanced internal valve design.

- **Minimal Plumbing:** Requires only one air line to fill tank and trigger valve.
- **Outstanding Performance, Modest Price:** Negative-pressure firing and the most direct air path provides effective performance in challenging applications with limited budgets.

ONE-STEP MAINTENANCE

The complete valve assembly can be removed in one easy step, working from one side of the tank, and replaced within minutes to keep your process running. There is no need to ever remove the tank from the vessel for service.



UNDERSTANDING VALVE DESIGN

Martin Engineering offers a full line of air cannon technologies; representing both established traditional designs and the latest leading-edge innovations in valve design, as well as hybrid and multiple-valve technologies.

This matrix provides an overview of the range of valve designs and air cannons available from Martin Engineering.



POSITIVE-PRESSURE FIRING
Requires pulse of air to trigger discharge, eliminating unintentional firings due to drops in pressure.

CENTRAL VALVE DESIGN

Compact, powerful, and efficient, the complete valve assembly is centrally housed within the tank.

MARTIN® HURRICANE

Most direct air path, maximum force output, minimal air consumption, smallest footprint, simplest installation, and one-step maintenance.

See page 4





NEGATIVE-PRESSURE FIRING

Minimal plumbing requires only one line of air to fill tank and trigger valve.

MARTIN® TYPHOON

Hybrid design combines minimal plumbing with the most direct air path and maximum force output of centrally-located Hurricane valve technology.

See page 5





MARTIN® 6 PACK PROGRAM

FACTORY WARRANTIED AIR CANNON VALVES

Buy a “6 pack” of Hurricane or Typhoon replacement valves to stock on your shelf. **Guaranteed** against defects, new valves carry the **full factory warranty**.

Your 6 pack comes in a standard pallet-sized container for easy handling and storage.

- 10-minute change out
- Stock only one part in your warehouse
- Have an easy replacement process by using our purpose built container
- Save up to 20%
- Martin® Factory-Direct New Tool Guarantee



The product appearance may differ



STEPS TO REPLACING A VALVE



1. De-energize air cannon from source and discharge the tank



2. Remove valve from tank



3. Replace old valve with Martin® Factory Direct Air Cannon Valve from "6 Pack"



4. Install replacement valve body on tank

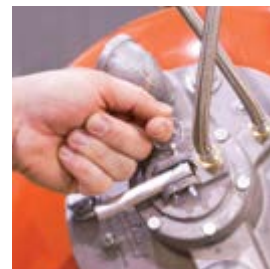

5. Reconnect air lines, pressurize, test fire

**See operator manual for complete instructions.*

VALVES



MARTIN® HURRICANE RETROFIT VALVE

Martin® Hurricane Air Cannon improves the flow of bulk materials and prevent outages due to discharge blockages, buildups and ratholes. The Hurricane features a new valve concept that provides more force, uses less air and simplifies installation and maintenance.

- **Twice the force for half the air consumption** when compared to our standard XHV 20-30 Air Cannon.
- **Simple one-step maintenance program** with all moving parts contained within a single assembly.
- **Increased safety** with a positive firing system; ensures the cannon fires only when you want it to.



MARTIN® TYPHOON RETROFIT VALVE

The Martin® Typhoon Air Cannon features a hybrid valve concept that provides more force, uses less air and simplifies maintenance in challenging applications with limited budgets.

- **60% more blast force and half the air consumption** when compared to our standard XHV 20-30 Air Cannon.
- **Single air line system.**
- **Simple one-step maintenance program** with all moving parts contained within a single assembly.



ACCESSORIES



MARTIN® THERMO SAFETY SHIELD

Slide gate safety valve allows timely maintenance on air cannons in high temperature processes without requiring the tank to be dismantled.

- **Improve Employee Safety:** Shelters workers from exposure to severe heat, gases, and high temperature material.
- **Simple to Install:** Sliding shield bolts between air cannon valve and mounting flange.
- **Secure, yet Simple to Operate:** Sliding shield operates under tough conditions, yet can be locked out to prevent intrusion.



MARTIN® SOLENOID BANK WITH OR W/O TIMER

Energizes the solenoid valves to provide automatic sequencing control of up to ten air cannons.



MARTIN® AIR CANNON CONTROLLER

Energizes the solenoid valves to control the discharge for a system of up to twelve Martin® Air Cannons.

- **Precision Flow Management:** Provides automatic sequencing of the discharge of up to twelve cannons.
- **Easy to Program:** Integral keypad and LCD make it simple to set or adjust firing schedule.
- **Indoor or Outdoor Installation:** Enclosure is water-tight/dust-tight/corrosion-resistant.

MARTIN® SMART™ SERIES JET NOZZLE

QUICK AND EASY REPLACEMENT

The Martin® SMART™ Series Jet Nozzle offers a simple yet innovative solution to the age-old problem of labor-intensive nozzle replacement. Eliminate the time and cost of cutting holes and breaking refractory to replace worn out nozzles.

- Replacement is quick and easy
- Limits or entirely eliminates damage to surrounding refractory
- No need to remove the air cannon tank (for Y-pipe nozzles)
- Eliminates improper alignment
- No entry required into the tower or cooler
- Provides the wide area of influence of a standard fan nozzle
- Available in straight or "Y" pipe arrangement

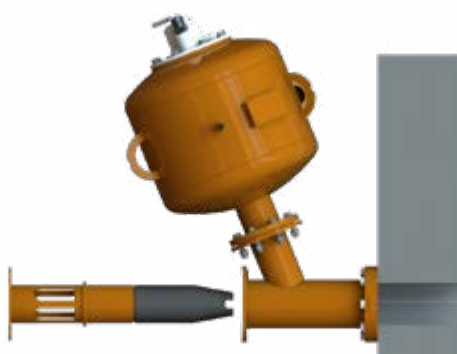
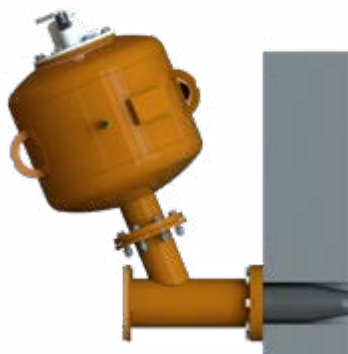

BLAST PATTERNS



Standard Pipe Nozzle

+



Standard Fan Jet Nozzle

=



Round Fan Jet Nozzle



MARTIN® SMART™ SERIES RETRACTABLE NOZZLE 360°



360-DEGREE CLEANING

The Martin® SMART™ Series Retractable Nozzle 360° is used for hard to reach locations in cement towers and other high-temp applications. The 360-degree nozzle makes cleaning on the center of the wall possible. Serviceable from the outside of the tower/vessel, so no waiting until the next scheduled outage for nozzle assembly replacement.

- 360-degree effective cleaning area
- Nozzle extends to fire then retracts to protect exposed tip from extreme heat
- Works with standard air cannons (150L Martin® Hurricane or Typhoon is recommended)
- Nozzle weldment is serviceable from the outside of the riser duct
- Controlled by one solenoid (110 volt / 220 volt / 24 volt)
- Less aggressive than blasting, eliminating damage to refractory from improper use of compressed CO₂



BLAST PATTERN



360° Nozzle

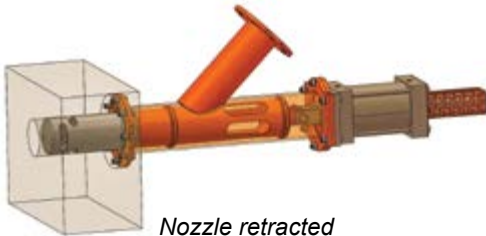

Nozzle retracted

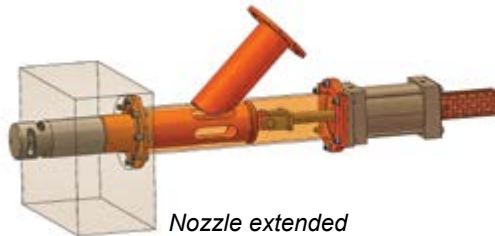

Nozzle extended

MARTIN® CORE GATE

SAFELY INSTALL AIR CANNONS & NOZZLES

No entry required • No outage • No loss of production

The ONLY technology to safely install Air Cannons and Nozzles while in production

- Safe, quick and easy Installation
- Install while in production
- Works with Martin® Smart Series Nozzles



NOZZLES

AMBIENT-TEMPERATURE NOZZLES

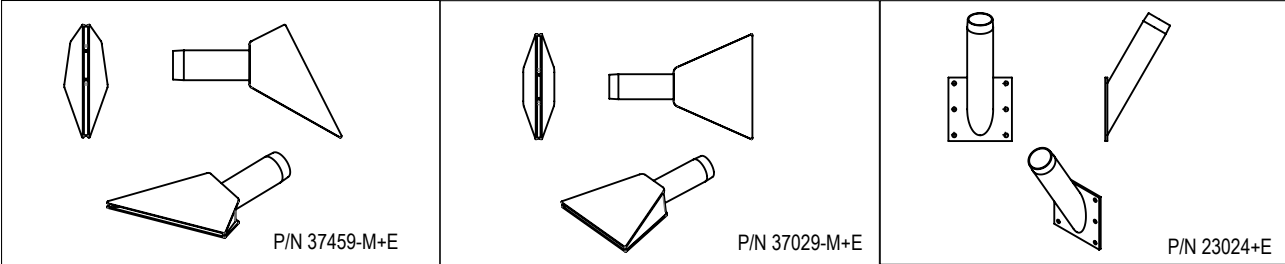

HIGH-TEMPERATURE NOZZLES

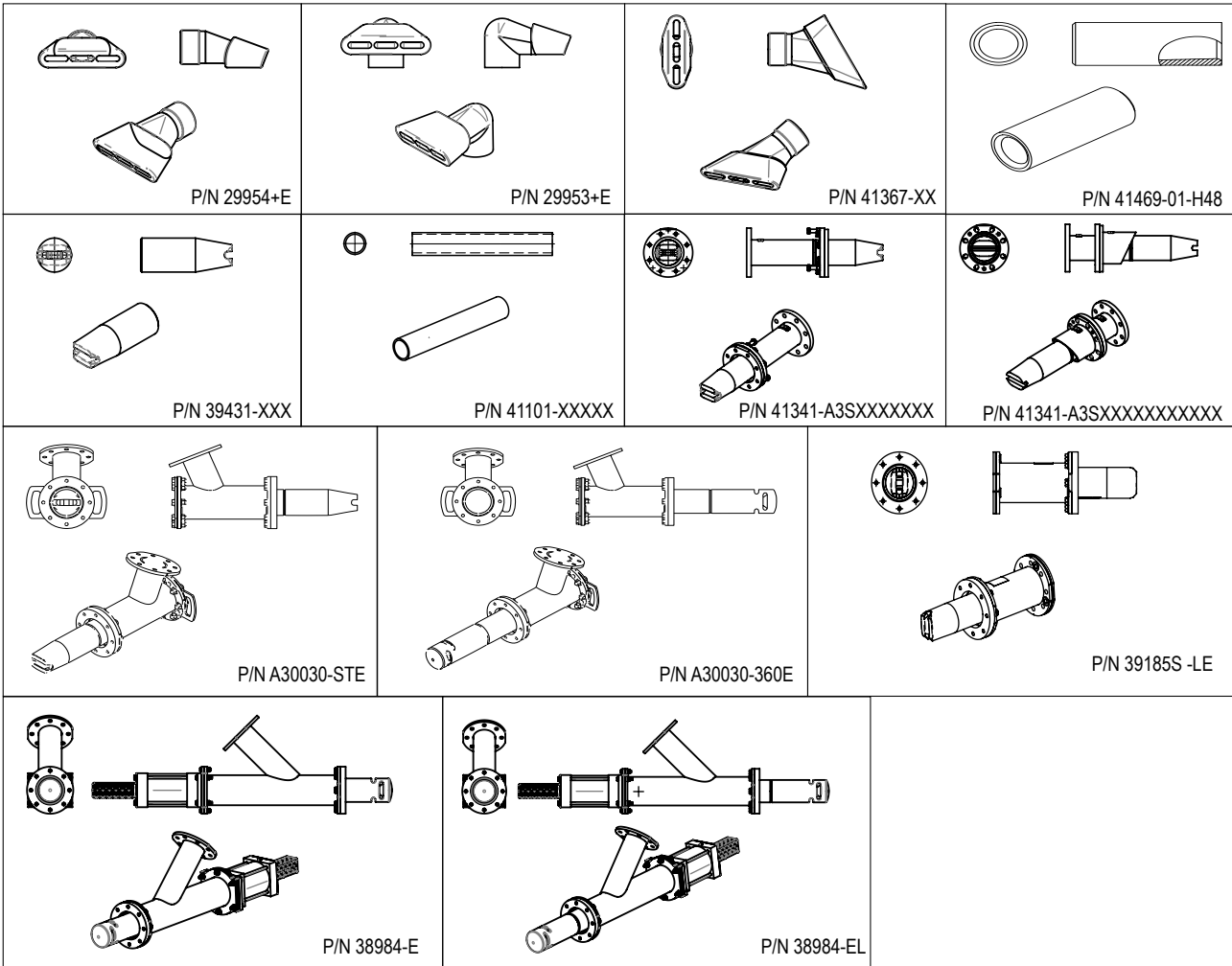

Martin provides a wide range of nozzles to suit your specific applications.

AIR CANNONS

MARTIN® HURRICANE

35L Assembly P/N	38005-035-10DCP+E
70L Assembly P/N	38005-070-10DCP+E
150L Assembly P/N	38005-150-10DCP+E
Technical Data Sheet P/N	L3800

MARTIN® TYPHOON

35L Assembly P/N	38005-035FD-10DCP+E
70L Assembly P/N	38005-070FD-10DCP+E
150L Assembly P/N	38005-150FD-10DCP+E
Technical Data Sheet P/N	L3809

Martin provides a wide range of vessels to suit your specific applications.

REPLACEMENT VALVES

MARTIN® HURRICANE VALVE

Valve Assembly P/N	38071-E+E
Operator Manual P/N	M3737

MARTIN® TYPHOON VALVE

Valve Assembly P/N	38071-FD-E
Operator Manual P/N	M3813

MARTIN® 6 PACK

Martin® 6 Pack Hurricane P/N	38071-E-6R
Martin® 6 Pack Typhoon P/N	38071-FD-E-6R

SMART™ SERIES NOZZLES

MARTIN® SMART™ SERIES JET NOZZLE

High-Temp Straight Y-Pipe Nozzle Assembly P/N	A30030-STE
High-Temp Y-Pipe Nozzle with Extended 45° Nozzle Assembly P/N	A30030-45E
High-Temp Y-Pipe Nozzle with Extended 90° Nozzle Assembly P/N	A30030-90E
High-Temp Y-Pipe Nozzle with Extended 180° Nozzle Assembly P/N	A30030-180E
High-Temp Y-Pipe Nozzle with Extended 360° Nozzle Assembly P/N	A30030-360E

MARTIN® SMART SERIES RETRACTABLE NOZZLE 360°

Nozzle Assembly P/N	38984-E / 38984-EL
Replacement Nozzle P/N	38983-NW
Technical Data Sheet P/N	L3935

ACCESSORIES

MARTIN® AIR CANNON CONTROLLER

Solenoid Bank (with or without timer) Operates up to ten air cannons	
Assembly P/N	41362-XXXXXXX
Controller for up to twelve air cannons	
Assembly P/N	41775-XXXXXXX

MARTIN® THERMO SAFETY SHIELD

















4-in. Flanged Assembly P/N	38189-4F-E
Technical Data Sheet P/N	L3622

MARTIN® CORE GATE

Assembly P/N	39351-CG-E
--------------	------------



GLOBAL LOCATIONS

 UNITED STATES	 INDIA	 PERU
 AUSTRALIA	 INDONESIA	 SPAIN
 BRAZIL	 ITALY	 SOUTH AFRICA
 CHINA	 MALAYSIA	 TURKEY
 FRANCE	 MEXICO	 UNITED KINGDOM
 GERMANY		

Authorized representatives in over 32 additional countries

MARTIN ENGINEERING SARL

50 Avenue d'Alsace,
68025 Colmar Cedex, France
Tél +33 389 20 63204
Fax +33 389 20 4379
info@martin-eng.fr
www.martin-eng.fr