

PART NUMBER	BELT WIDTH	DIMENSION "A" BLADE COVERAGE	DIMENSION "B" FRAME LENGTH
39346-181X12XXX	18.00 [400-500]	12.00 [305]	44.00 [1119]
39346-181X16XXX	18.00 [400-500]	16.00 [406]	44.00 [1119]
39346-241X18XXX	24.00 [500-650]	18.00 [457]	50.00 [1270]
39346-241X22XXX	24.00 [500-650]	22.00 [559]	50.00 [1270]
39346-301X24XXX	30.00 [650-800]	24.00 [610]	62.00 [1575]
39346-301X28XXX	30.00 [650-800]	28.00 [711]	62.00 [1575]
39346-361X30XXX	36.00 [800-1000]	30.00 [762]	68.00 [1727]
39346-361X34XXX	36.00 [800-1000]	34.00 [864]	68.00 [1727]
39346-421X36XXX	42.00 [1000-1200]	36.00 [914]	74.00 [1880]
39346-421X40XXX	42.00 [1000-1200]	40.00 [1016]	74.00 [1880]
39346-481X42XXX	48.00 [1200-1400]	42.00 [1067]	80.00 [2032]
39346-481X46XXX	48.00 [1200-1400]	46.00 [1168]	80.00 [2032]

ASSEMBLY PART NO.	COLOR
39346-XX1XXXBRX	BROWN
39346-XX1XXXCLX	TAN
39346-XX1XXXGRX	GREEN
39346-XX1XXXNBX	NAVY BLUE
39346-XX1XXXORX	ORANGE

- NOTES:
- 1) ALL DIMENSIONS ARE GIVEN IN INCHES [MM] AND ARE FOR REFERENCE ONLY.
 - 2) IN THE 39346-XX1XXXXX PART NUMBER THE FIRST TWO XX'S INDICATE THE BELT WIDTH. THE "1" INDICATES A BLADE WITHOUT SLITS. SLITS ARE NOT AVAILABLE ON THIS BLADE ASSEMBLY. THE THIRD X INDICATES A SOLID (1) OR SEGMENTED (0) BLADE. THE NEXT TWO XX'S INDICATE THE BLADE WIDTH. THE NEXT TWO XX'S INDICATE THE BLADE COLOR/MATERIAL (SEE BLADE COLOR CHART), THE LAST X INDICATES IF A TENSIONER IS INCLUDED.
 - 3) THE FRAME IS ADJUSTABLE TO DESIRED LENGTH.
 - 4) FOR BELT WIDTHS 54.00 [1372] AND OVER, MARTIN ENGINEERING RECOMMENDS USING A DUAL TWIST TENSIONER ASSEMBLY (P/N 38850-2). SEE S50109-D.
 - 5) WHERE EXTREME OR UNUSUAL CONDITIONS EXIST, OR SPECIAL MAINFRAME LENGTHS ARE REQUIRED CONTACT MARTIN ENGINEERING.
 - 6) TWIST TENSIONER MAY BE BOLTED OR WELDED IN PLACE. MARTIN ENGINEERING RECOMMENDS BOLTING WHEN APPLICABLE FOR EASIER MAINTENANCE AND ACCESSIBILITY. IF WELDING IS REQUIRED USE TWIST TENSIONER P/N 38850-A. REFER TO OPERATOR'S MANUALS M3837 AND M4022 FOR INSTALLATION INSTRUCTIONS.
 - 7) CLEANER CAN BE LOCATED ANYWHERE ALONG THE ARC, AS LONG AS THE MAINFRAME IS OUT OF MATERIAL TRAJECTORY AND THE BLADE TIPS ARE BELOW THE HORIZONTAL CENTERLINE OF THE HEAD PULLEY.
 - 8) FOR SEVERE APPLICATIONS WELD MAINFRAME ADAPTER DIRECTLY TO MAINFRAME.
 - 9) THE QB1 HD PRE-CLEANER BLADE IS DESIGNED TO REMOVE THE INITIAL CARRYBACK ONLY. DO NOT OVERTENSION.
 - 10) THE QB1 HD PRE-CLEANER BLADE IS DESIGNED FOR HEAD PULLEYS WITH A MINIMUM EFFECTIVE DIAMETER OF 12.00 [305].
 - 11) BLADE COVERAGE IS LESS THAN BELT WIDTH, DUE TO POSSIBLE MISTRACKING OR DAMAGED EDGES OF THE BELT.

ITEM	QTY.	DESCRIPTION	PART NUMBER
1	1	MARTIN® QB1 HD BLADE MAINFRAME ASM	39346-XX1XXXXX
2	1	MARTIN® TWIST™ TENSIONER ASM	38850
3	1	MARTIN® LOW PROFILE STL DOOR 9X12	CYA-0912

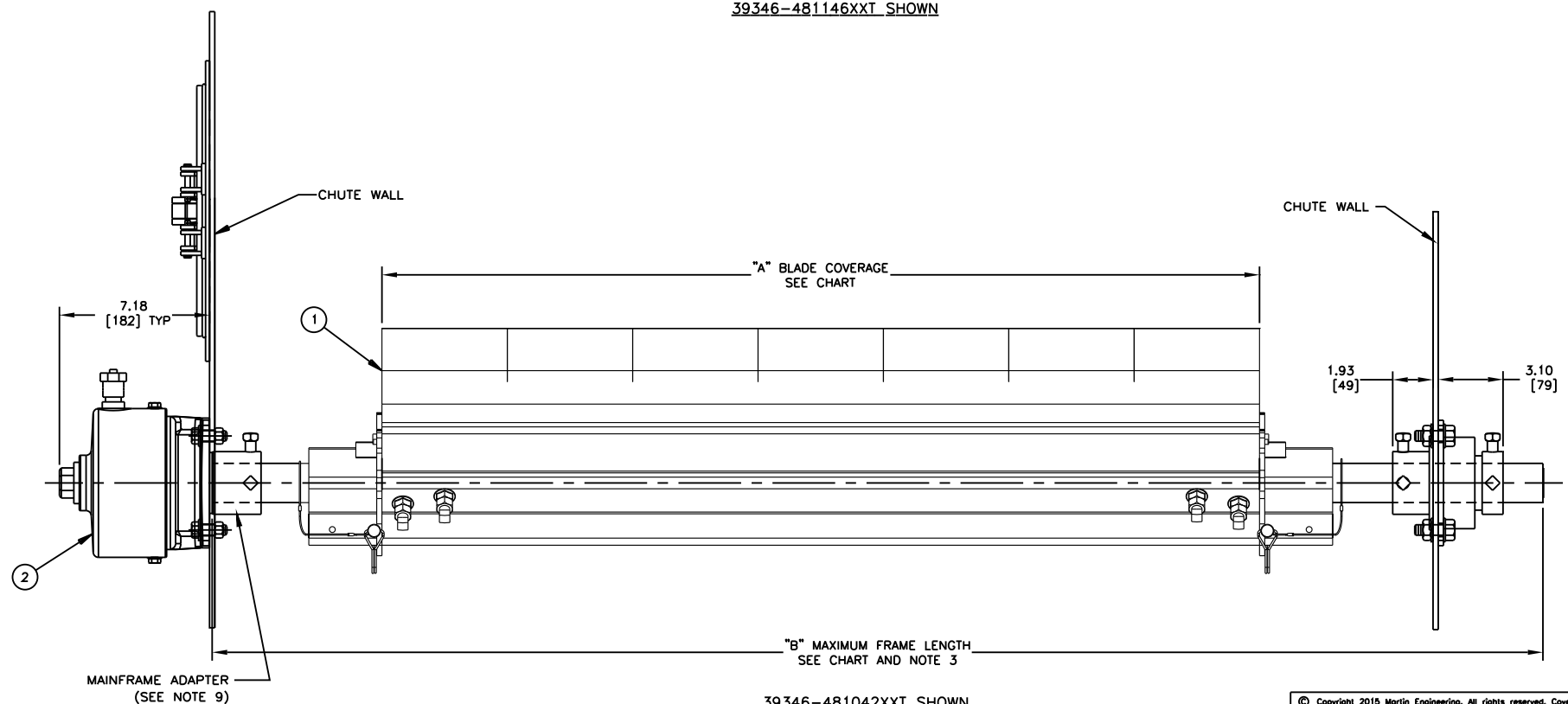
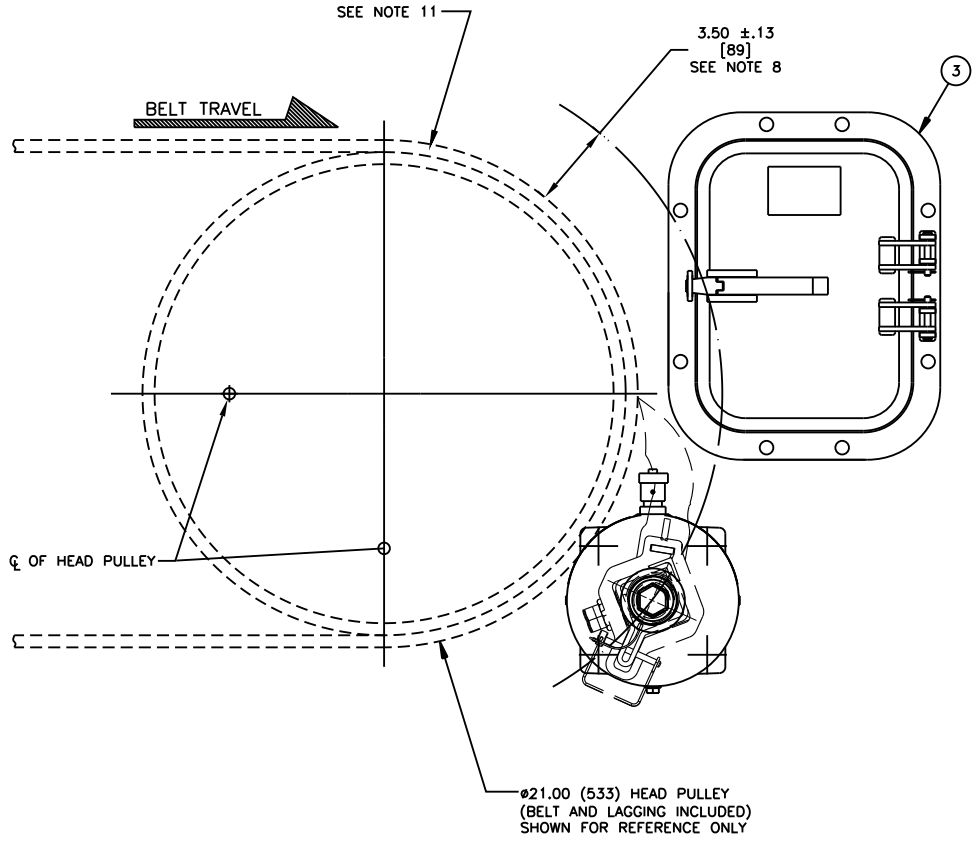
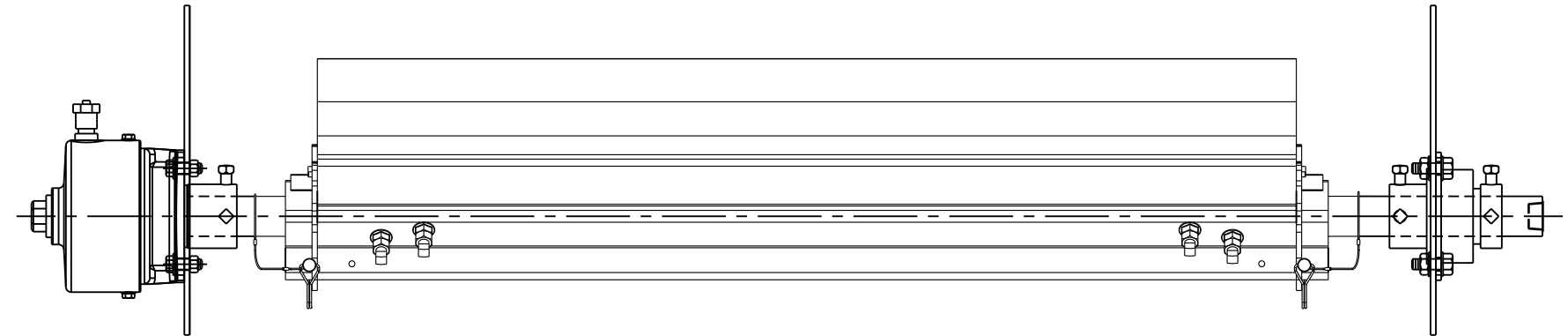
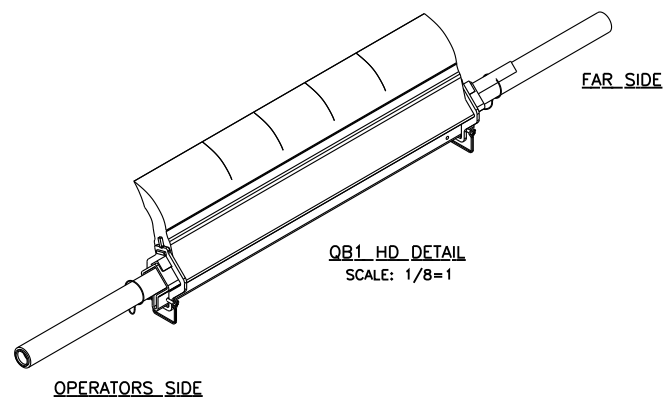
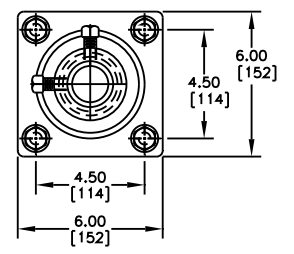
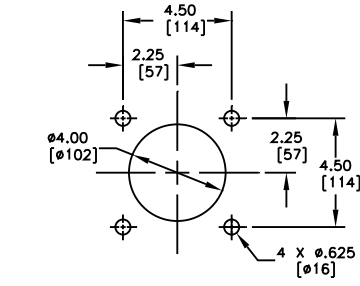
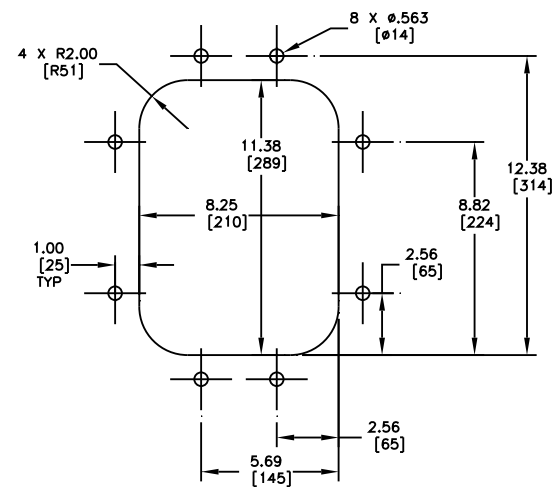

© Copyright 2015 Martin Engineering. All rights reserved. Covered by U.S. and foreign patents pending and issued. ® and TM indicate trademarks of Martin Engineering.

MARTIN ENGINEERING-USA
NEPONSET, IL USA

TITLE: MARTIN® QB1 HD ASM WITH TWIST™ TENSIONER ASM & 9 X 12 STEEL DOOR

DRAWN RND: DATE 01/19/15
CHECKED: DATE 01/20/15
APPROVED: DATE 01/21/15
SCALE 1/4

NO.	DESCRIPTION	ECN	DATE	BY
AutoCAD	REVISION			

SALES DRAWING: PR128988 S50109-S

