

***martin***®

# ***Martin***® ***Spring Cable Tensioner***

[Go to Martin® Spring Cable Tensioner web page](#)



***Operator's Manual***  
***M3734***

# Important

MARTIN ENGINEERING HEREBY DISCLAIMS ANY LIABILITY FOR: DAMAGE DUE TO CONTAMINATION OF THE MATERIAL; USER'S FAILURE TO INSPECT, MAINTAIN AND TAKE REASONABLE CARE OF THE EQUIPMENT; INJURIES OR DAMAGE RESULTING FROM USE OR APPLICATION OF THIS PRODUCT CONTRARY TO INSTRUCTIONS AND SPECIFICATIONS CONTAINED HEREIN. MARTIN ENGINEERING'S LIABILITY SHALL BE LIMITED TO REPAIR OR REPLACEMENT OF EQUIPMENT SHOWN TO BE DEFECTIVE.

Observe all safety rules given herein along with owner and Government standards and regulations. Know and understand lockout/tagout procedures as defined by American National Standards Institute (ANSI) z244.1-1982, *American National Standard for Personnel Protection - Lockout/Tagout of Energy Sources - Minimum Safety Requirements* and Occupational Safety and Health Administration (OSHA) Federal Register, Part IV, 29 CFR Part 1910, *Control of Hazardous Energy Source (Lockout/Tagout); Final Rule*.

The following symbols may be used in this manual:



**Danger:** Immediate hazards that will result in severe personal injury or death.



**Warning:** Hazards or unsafe practices that could result in personal injury.



**Caution:** Hazards or unsafe practices that could result in product or property damages.



**Important:** Instructions that must be followed to ensure proper installation/operation of equipment.



**Note:** General statements to assist the reader.

# Table of Contents

---

<b>Section</b>	<b>Page</b>
List of Figures and Tables .....	ii
Introduction .....	1
General .....	1
Safety .....	1
References .....	2
Before Installing Tensioner .....	3
Installing Tensioner .....	4
Locating and cutting mounting holes .....	4
Installing mounting plates .....	8
Installing tensioner .....	9
After Installing Tensioner .....	16
Weekly Maintenance .....	17
Troubleshooting .....	19
Part Numbers .....	20

# List of Figures

---

<b>Figure</b>	<b>Title</b>	<b>Page</b>
1	Martin <sup>®</sup> Spring Cable Tensioner Assembly, P/N 37944 . . . . .	21
2	Conveyor Products Warning Label, P/N 23395 . . . . .	24
3	Pinch Point Warning Label, P/N 30528 . . . . .	24
4	Martin <sup>®</sup> Spring Cable Tensioner Tensioning Guide Label, P/N 37932 . . . . .	25

# Introduction

## General

The Martin® PV Cleaner combined with the Martin® Spring Cable Tensioner provides effective removal of carryback with “quick-release” one-pin, no-tool blade replacement. To introduce product back into the product flow, the Martin® PV Cleaner is installed on the face of the head pulley. If the material-handling process or product could be affected by contamination from the use of this belt cleaner, the user is responsible for taking the necessary steps to prevent contamination. Consult Martin Engineering or a representative for alternate belt cleaners or belt cleaner locations to use where contamination may be an issue.

## Safety



**⚠ DANGER**

Do not touch or go near the conveyor belt or conveyor accessories when the belt is running. Your body or clothing can get caught and you can be pulled into the conveyor, resulting in severe injury or death.



**⚠ DANGER**

Before installing, servicing or adjusting the belt cleaner/tensioner, turn off and lock out/tag out all energy sources to the conveyor and conveyor accessories according to ANSI standards. Failure to do so could result in serious injury or death.

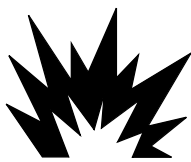

**⚠ DANGER**

If this equipment will be installed in an enclosed area, test the gas level or dust content before using a cutting torch or welding. Using a torch or welding in an area with gas or dust may cause an explosion resulting in serious injury or death.



**⚠ WARNING**

Before using a cutting torch or welding the chute wall, cover the conveyor belt with a fire retardant cover. Failure to do so can allow the belt to catch fire.

## *References*

The following documents are referenced in this manual:

- American National Standards Institute (ANSI) z244.1-1982, *American National Standard for Personnel Protection - Lockout/Tagout of Energy Sources - Minimum Safety Requirements*, American National Standards Institute, Inc., 1430 Broadway, New York, NY 10018.
- Federal Register, Volume 54, Number 169, Part IV, 29 CFR Part 1910, *Control of Hazardous Energy Source (Lockout/Tagout); Final Rule*, Department of Labor, Occupational Safety and Health Administration (OSHA), 32nd Floor, Room 3244, 230 South Dearborn Street, Chicago, IL 60604.

# Before Installing Tensioner

---

## *Before installing tensioner*

### **IMPORTANT**

The delivery service is responsible for damage occurring in transit. Martin Engineering CANNOT enter claims for damages. Contact your transportation agent for more information.

1. Inspect shipping containers for damage. Report damage to delivery service immediately and fill out delivery service's claim form. Keep any damaged goods subject to examination.
2. Remove Martin® Spring Cable Tensioner from shipping containers. Equipment in containers should include the following:
  - Martin® Spring Cable Tensioner Assembly.
  - Two Conveyor Products Warning Labels, P/N 23395.
  - One Pinch Point Warning Label, P/N 30528
  - One Cable Tensioner Tensioning Label, P/N 37932
  - One Allen Wrench (6 mm), P/N 38037
3. If anything is missing or damaged, contact Martin Engineering or a representative.

### **IMPORTANT**

Read and understand the safety information in the previous section.

### **▲ WARNING**

Before installing equipment, turn off and lock out/tag out energy source to conveyor and conveyor accessories.

### **▲ WARNING**

If equipment will be installed in an enclosed area, gas level or dust content must be tested before using a cutting torch or welding. Using a cutting torch or welding in an area with gas or dust may cause an explosion.

### **NOTE**

The chute wall that the tensioner will be located on is referred to as the "operator side." The opposite chute wall is referred to as the "far side."

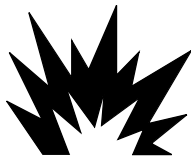

# Installing Tensioner

1  
*Locating and cutting mounting holes*

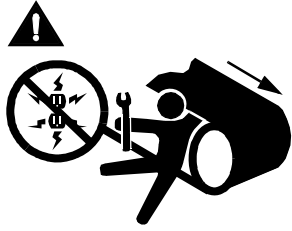

2

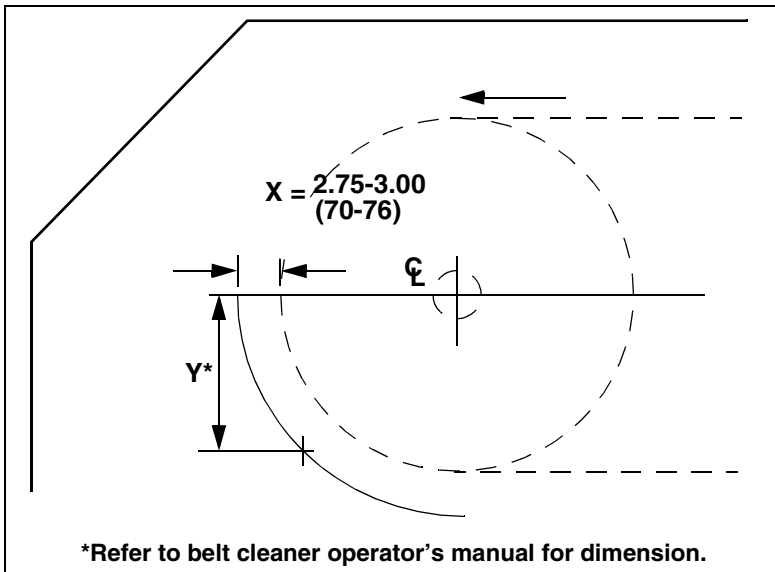



## 2 (cont)

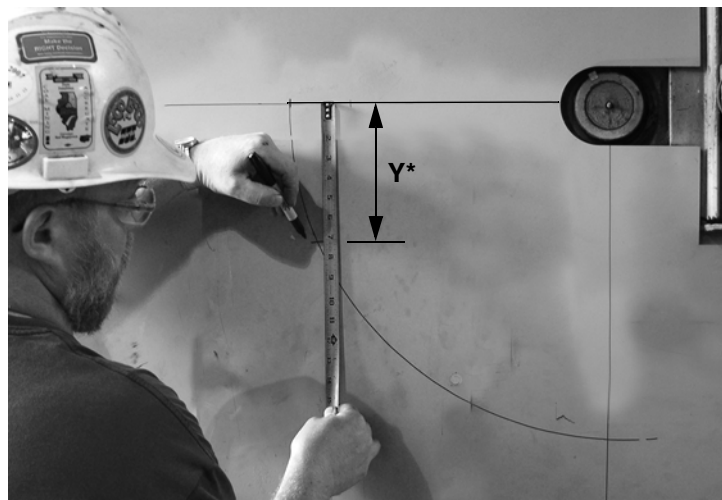
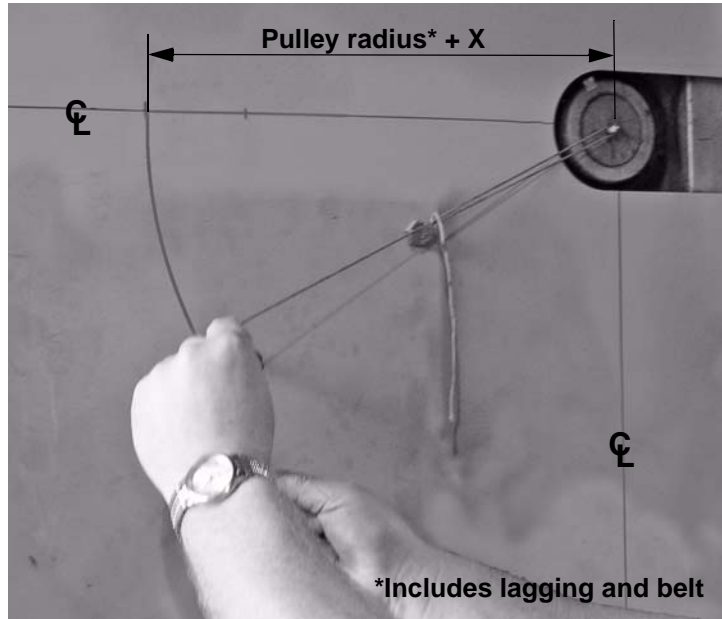

\*Refer to belt cleaner operator's manual for dimension.

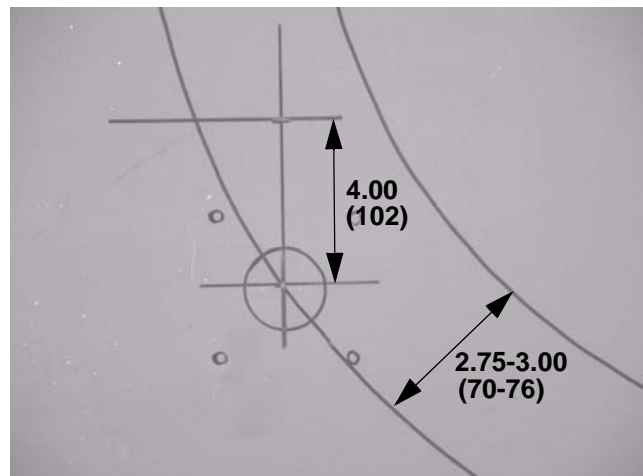
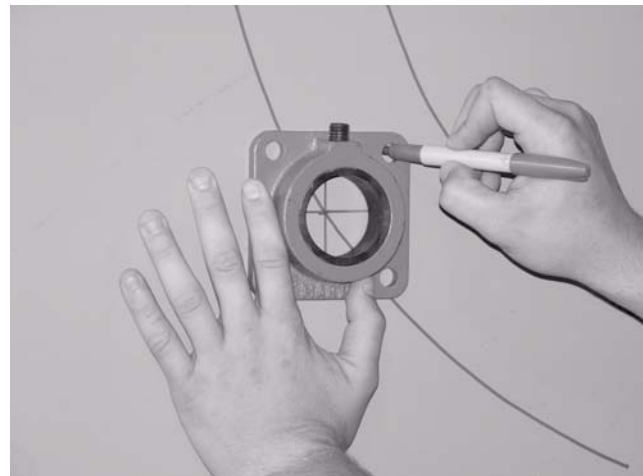
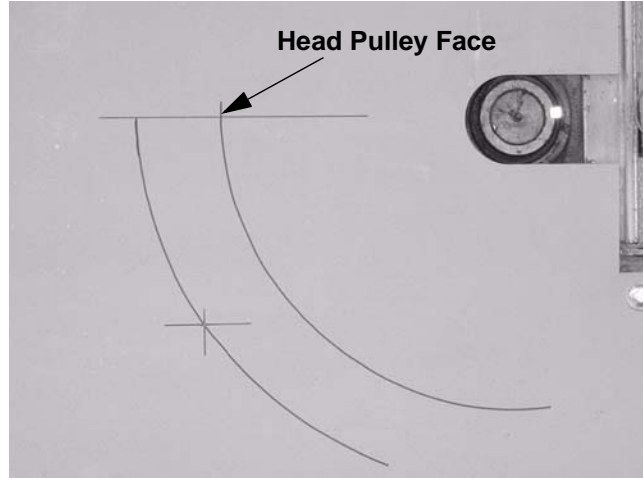

4

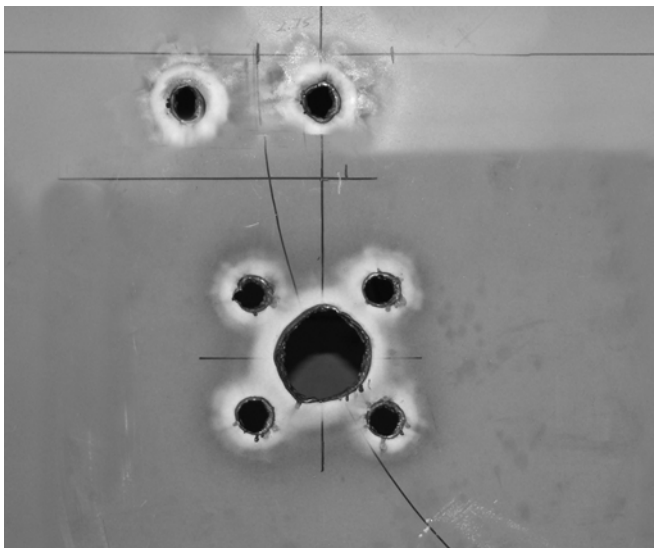
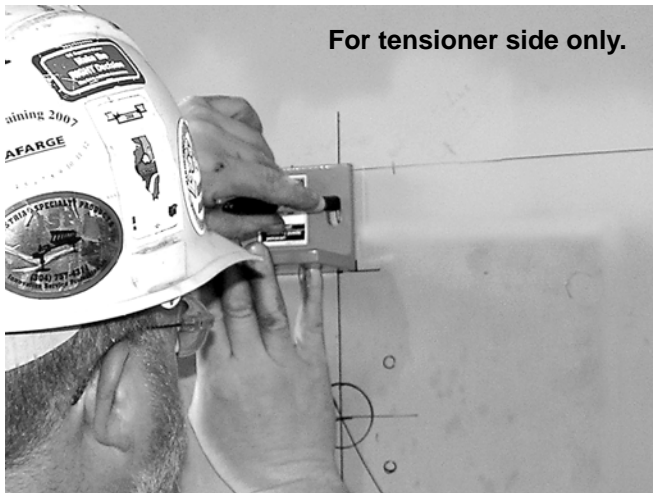

5 Repeat steps 2, 3 and 4 on far side of chute.

# Installation

6



## *Installing mounting plates*

1

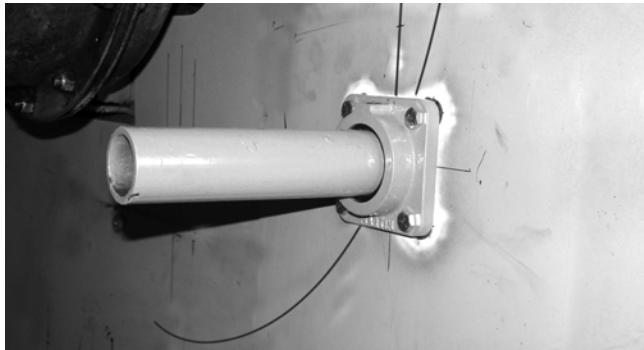

2

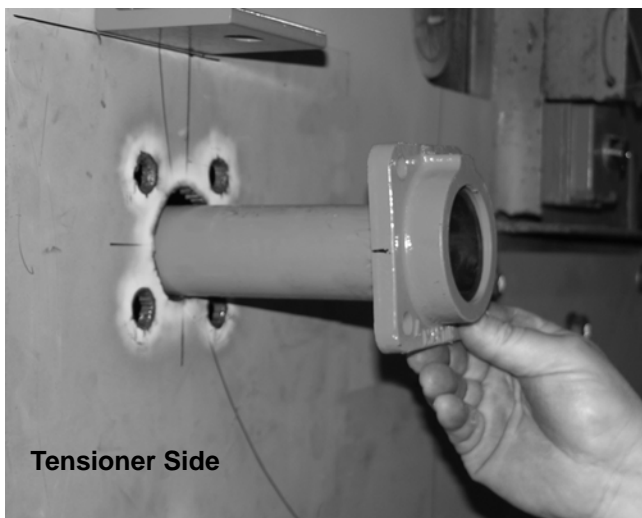

3 For dual tensioners, repeat step 5 under *Locating and cutting mounting holes* on far side as shown. For single tensioner, install far side mount plate.

*Installing tensioner*

1

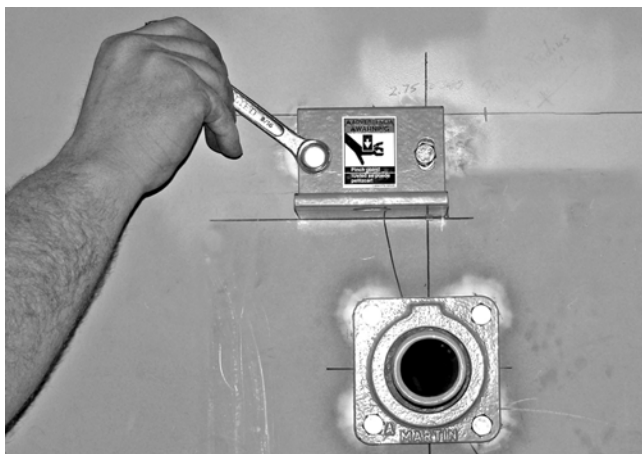

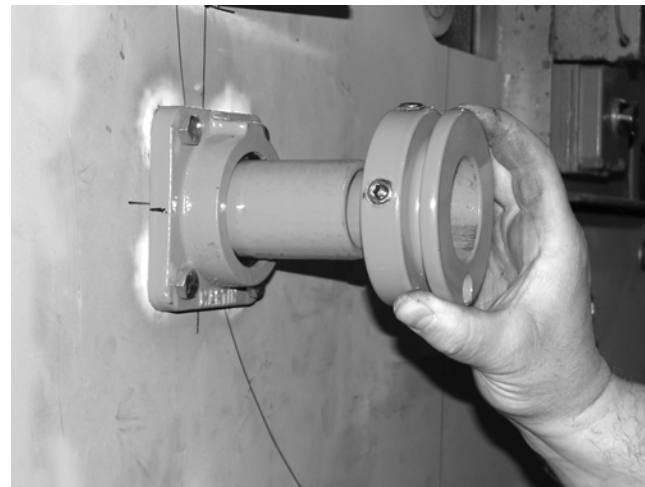
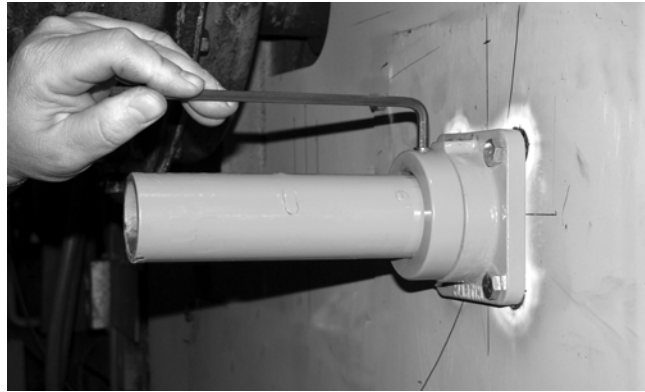

**IMPORTANT**

Prior to assembly of cable, check cable for loose strands, split ends, flat spots, corrosion of any kind, cable coming unraveled, and/or broken plastic cable cover. If any of these are found, replace cable before applying tension.

## 2 (cont.)

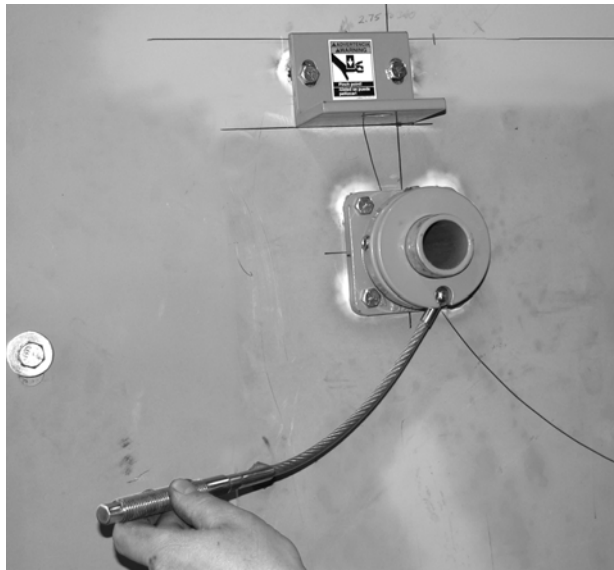

## 3

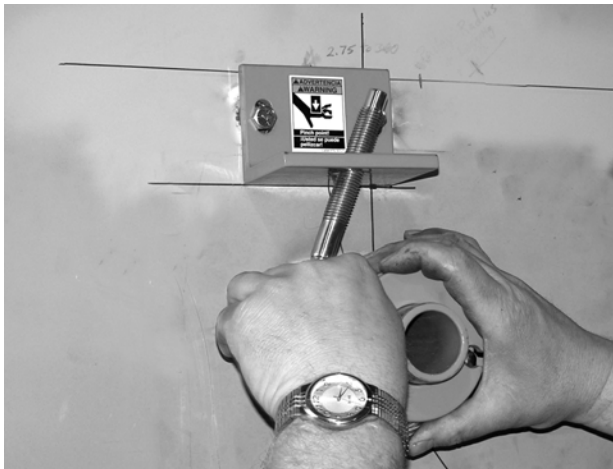

# Installation

4

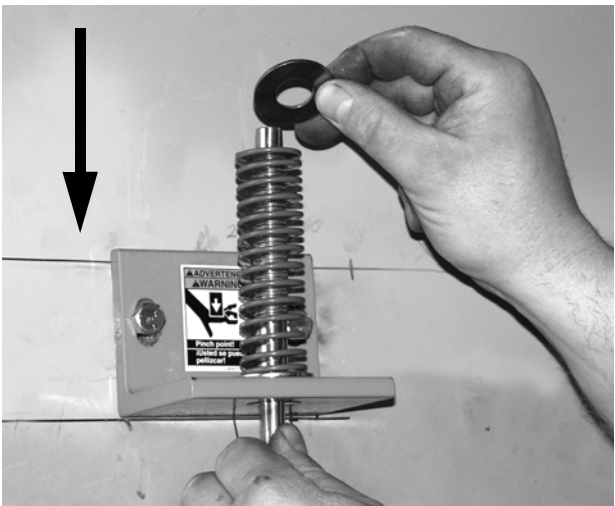
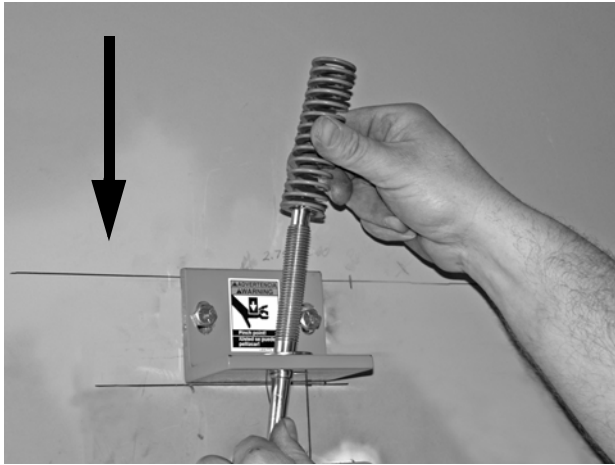
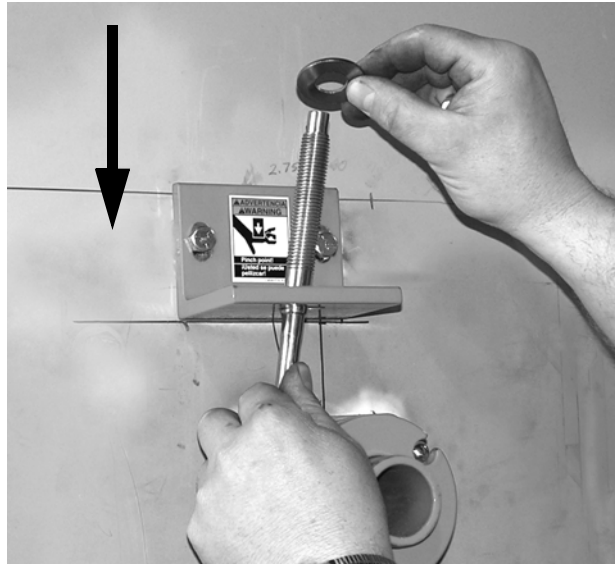



## 4 (cont.)

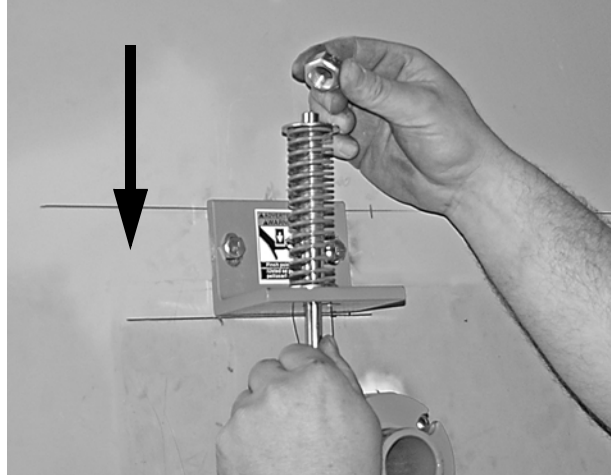

## 5

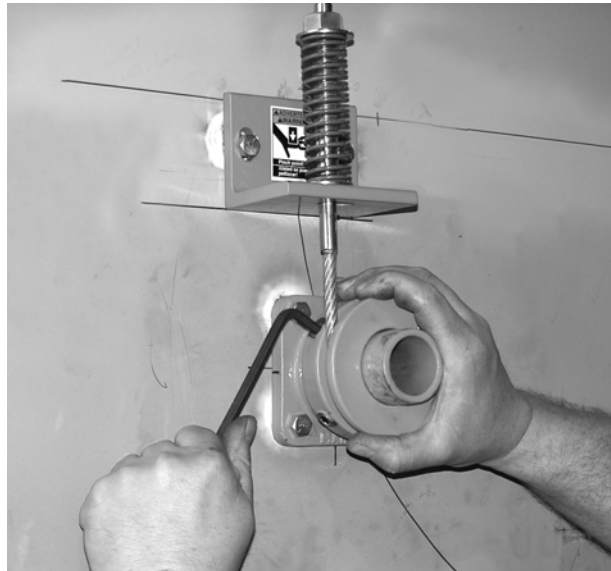

**NOTE**

To avoid unraveling the cable while tensioning, hold top of cable above spring with a wrench and adjust nuts until proper tension is achieved.

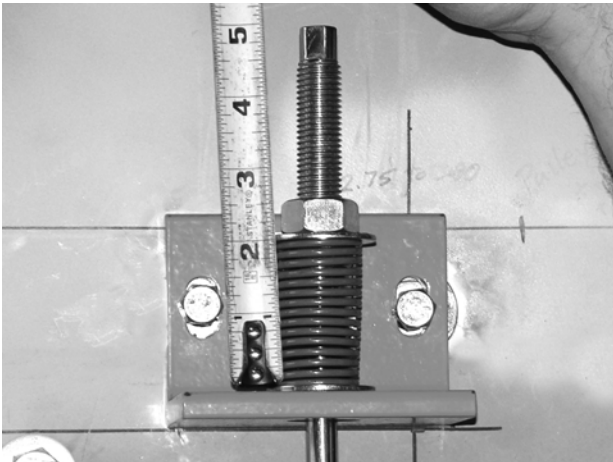
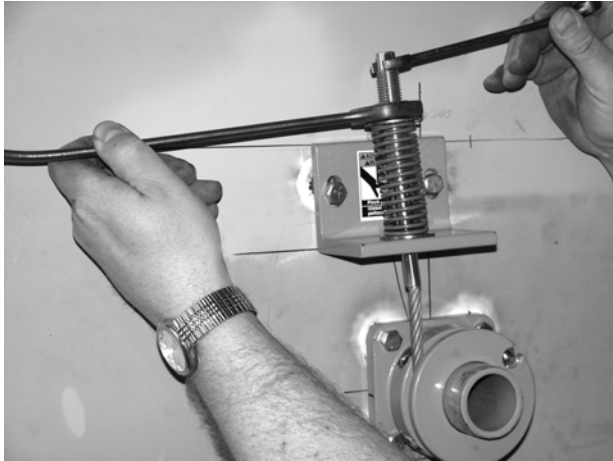

Martin® Spring Cable Tensioner Tensioning Guide	
Belt Width in. (mm)	Recommended Height in. (mm)
18 (450)	3.25 (83)
24 (600)	3.125 (79)
30 (750)	3.00 (76)
36 (900)	2.75 (70)
42 (1100)	2.625 (67)
48 (1200)	2.50 (64)
54 (1400)	2.25 (57)

7

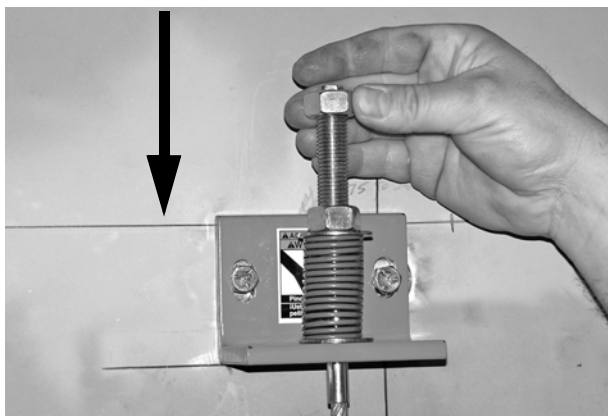

# After Installing Tensioner

1

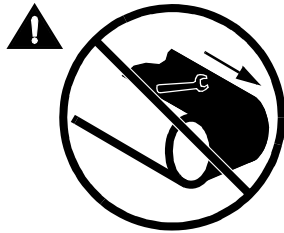

**⚠ WARNING**

Failure to remove tools from installation area and conveyor belt before turning on energy source can cause serious injury to personnel and damage to belt.



**⚠ DANGER**

Do not touch or go near conveyor belt or conveyor accessories when conveyor belt is running. Body or clothing can get caught and pull body into conveyor belt, causing severe injury or death.

2 Turn on conveyor belt for 1 hour, then turn off.

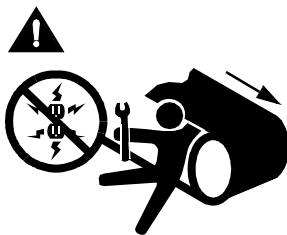

**⚠ DANGER**

Before installing, servicing or adjusting the belt cleaner/tensioner, turn off and lock out/tag out all energy sources to the conveyor and conveyor accessories according to ANSI standards. Failure to do so could result in serious injury or death.

3 Make sure all fasteners are tight. Tighten if necessary.

4 Inspect belt cleaner for the following:

- Wear. (A small amount of “break-in” wear may be found. This will stop once blades wear to conveyor belt contour.)
- Material buildup. (No material between blades and return side of conveyor belt should be found.)

5 If wear, material buildup, or some other problem exists, see “Troubleshooting.”

# Weekly Maintenance

## NOTE

Maintenance inspection should be performed no less than weekly. Your application may require more frequent maintenance inspections.

## IMPORTANT

Read entire section before beginning work.

## WARNING

Before servicing belt cleaner/tensioner, turn off and lock out/tag out energy source to conveyor belt and conveyor accessories. Turn off and lock out/tag out energy source according to ANSI standards (see “References”).

## WARNING

Do not reach into chute while conveyor is running.

- 1 Turn off and lock out/tag out energy source according to ANSI standards (see “References”).
- 2 Remove any material from belt cleaner.
- 3 Make sure all fasteners are tight. Tighten if necessary.
- 4 Wipe all labels clean. If labels are not readable, contact Martin Engineering or a representative for replacements.
- 5 Before blades are worn to wear line, replace blade. Remove worn blade, install new blade, and tension cleaner as shown in this manual. (Remember to check cable for any defects as noted when tensioning cleaner.)
- 6 Remove equipment from service if there is any indication it is not functioning properly. Call Martin Engineering or a representative for assistance. Do NOT return equipment to operation until the cause of the problem has been identified and corrected.

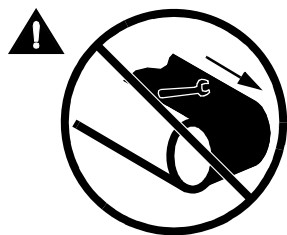
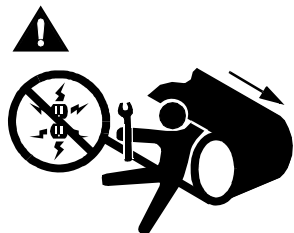

## WARNING

Failure to remove tools from maintenance area and conveyor belt before turning on energy source can cause serious injury to personnel and damage to belt.

- 7 Remove all tools from maintenance area.



**⚠ DANGER**

Do not touch or go near conveyor belt or conveyor accessories when conveyor belt is running. Body or clothing can get caught and pulled into conveyor belt, causing severe injury or death.

- 8 Start conveyor belt.

# Troubleshooting

If you are experiencing problems with belt cleaner, see below.

Symptom	Corrective Action
High blade wear rate.	Tension of cleaner on belt is set too high. Reduce tension.
More blade wear in center than on ends.	Pulley may be crowned. Use segmented blade or reduce blade coverage.
Unusual wear or damage to blades.	Check belt splice(s) and repair as necessary.
Noise or vibration.	Tension is not sufficient or is set too high. Correct tension as necessary. If this does not correct problem, blade urethane may not match application. Contact Martin Engineering or a representative.
Corrosion or chemical degradation.	Blade urethane may not match application. Contact Martin Engineering or representative.
Insufficient cleaning and carryback.	Tension of cleaner on belt is set too low or too high. Increase or decrease tensioner setting. Blade is worn. Check blade and replace if necessary. (See "Weekly Maintenance.")

## NOTE

**Conveyor equipment such as conveyor belt cleaners/ tensioners are subject to a wide variety of bulk materials characteristics and often have to perform under extreme operating or environmental conditions. It is not possible to predict all circumstances that may require troubleshooting. Contact Martin Engineering or a representative if you are experiencing problems other than those listed in the "Troubleshooting" chart above. Do not return the equipment to operation until the problem has been identified and corrected.**

## **Part Numbers**

---

This section provides product names and corresponding part numbers for Martin® Spring Cable Tensioners and related equipment. Please reference part numbers when ordering parts:

*Martin® Spring  
Cable Tensioner*

**Martin® Spring Cable Tensioner Assembly:** P/N 37944. See Figure 1.



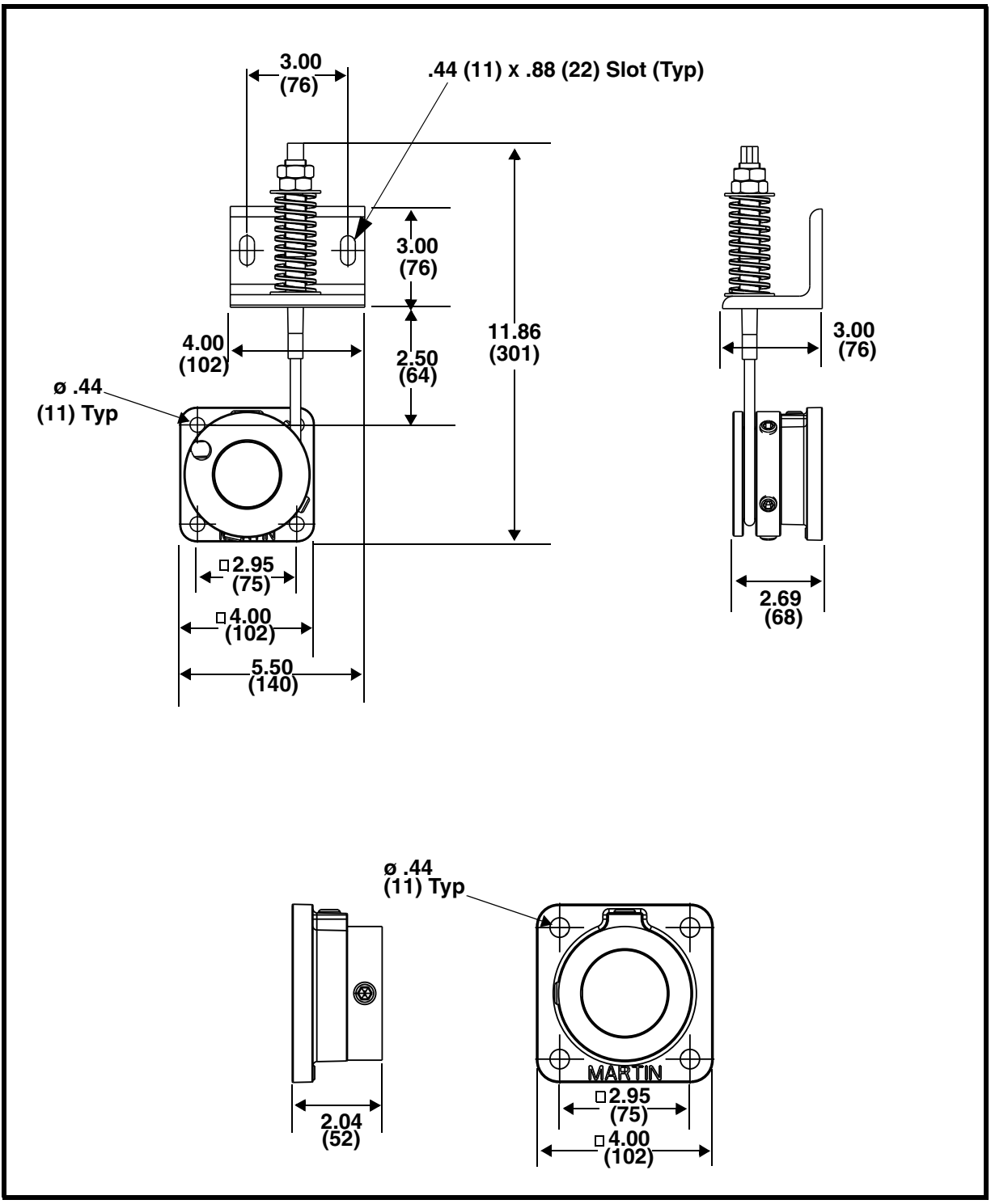

Figure 1. Martin® Spring Cable Tensioner Assembly, P/N 37944 (page 1 of 3)

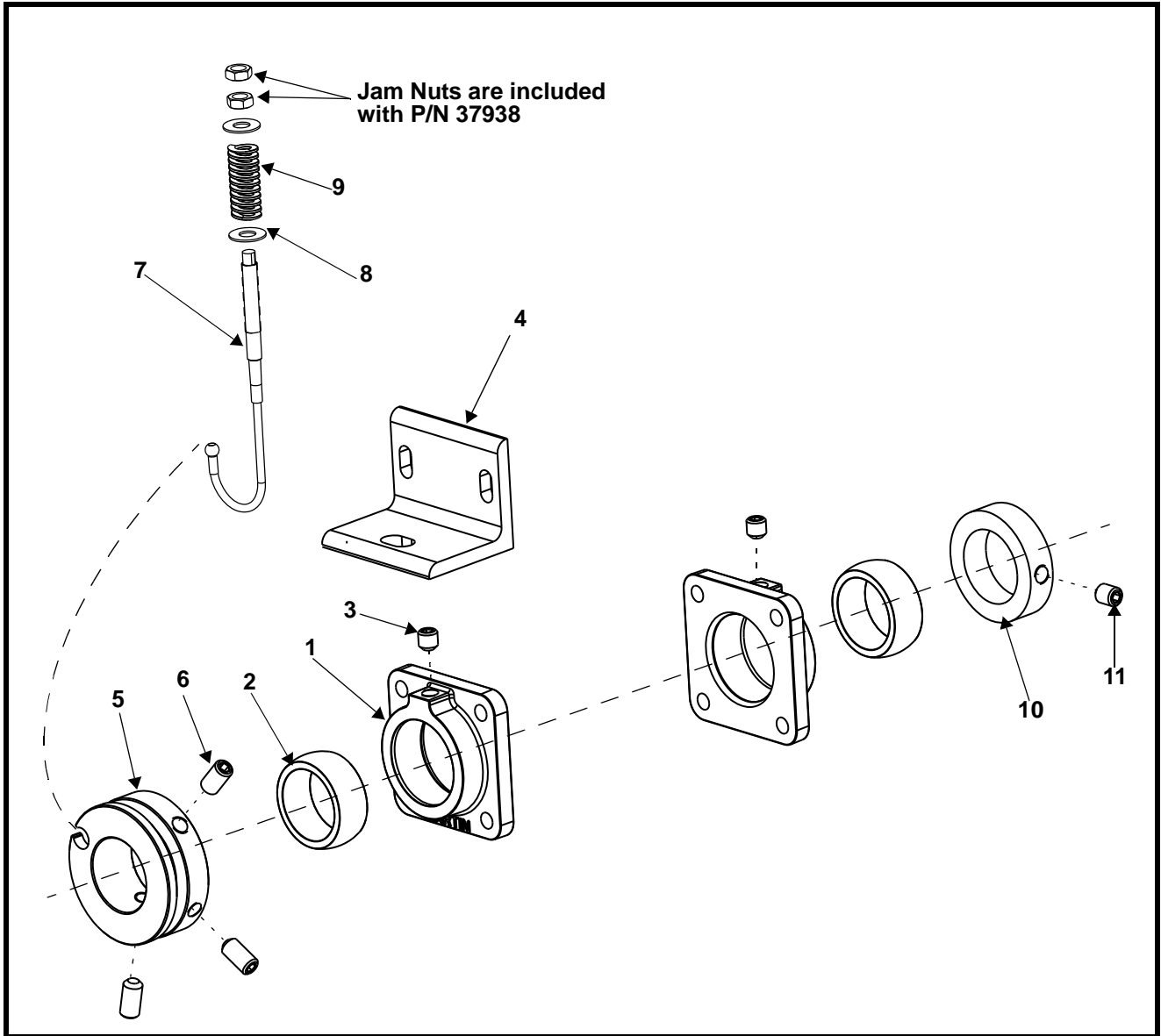

Figure 1. Martin® Spring Cable Tensioner Assembly, P/N 37944 (page 2 of 3)

<b>Item</b>	<b>Description</b>	<b>Part No.</b>	<b>Qty.</b>
1	Cable Tensioner Bearing Housing	37934	2
2	Cable Tensioner Nylon Bearing	37935	2
3	Screw Set Soc Cup 1/2-13NC x 1/2 SS	37943	2
4	Cable Tensioner Spring Bracket	37936	1
5	Cable Tensioner Hub	37937	1
6	Screw Set Soc Cup 1/2-13NC x 1 SS	37941	3
7	Cable Tensioner Cable Assembly	37938	1
8	Washer Flat 5/8 SS	23343	2
9	Spring Steel Die	37939	1
10	Shaft Locking Collar	37940	1
11	Screw Set Soc Cup 1/2-13NC x 5/8 SS	37942	1
12*	Cable Tensioner Mounting Hardware Kit	37945	1
13*	Label Cable Tensioner Tensioning	37932	1
14*	Label Pinch Point Warning	30528	1
15*	Label Conveyor Products Warning	23395	2
16*	Manual, Operator's	M3734	1
17*	Allen Wrench 6mm	38037	1

\*Not Shown

**Figure 1. Martin<sup>®</sup> Spring Cable Tensioner Assembly, P/N 37944 (page 3 of 3)**

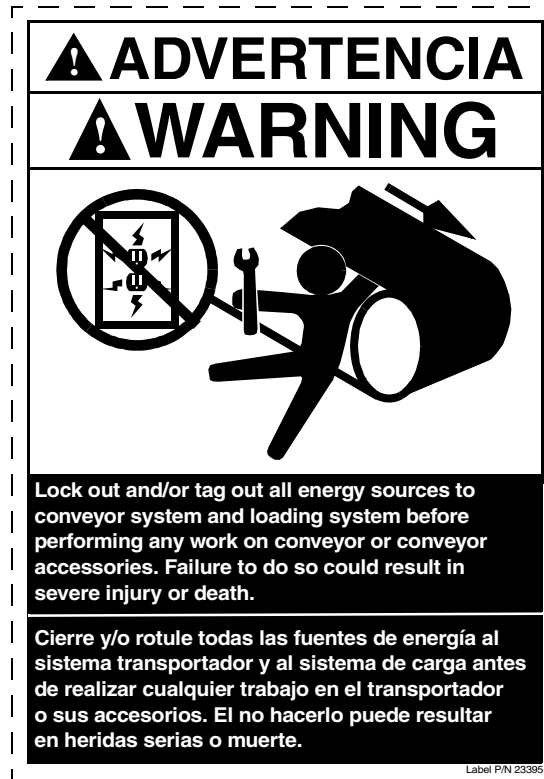

Figure 2. Conveyor Products Warning Label, P/N 23395



Figure 3. Pinch Point Warning Label, P/N 30528

Martin® Spring Cable Tensioner Tensioning Guide	
Belt Width in (mm)	Recommended Height in (mm)
18 (450)	3.25 (83)
24 (600)	3.125 (79)
30 (750)	3.0 (76)
36 (900)	2.75 (70)
42 (1100)	2.625 (67)
48 (1200)	2.5 (64)
54 (1400)	2.25 (57)

LABEL NO 37932

***martin***®

800-544-2947 OR 309-852-2384  
[www.martin-eng.com](http://www.martin-eng.com)

Figure 4. Martin® Spring Cable Tensioner Tensioning Guide Label, P/N 37932

## Notes

*Any product, process, or technology described here may be the subject of intellectual property rights reserved by Martin Engineering Company. Trademarks or service marks designated with the ® symbol are registered with the U.S. Patent and Trademark Office and may be proprietary in one or more countries or regions. Other trademarks and service marks belonging to Martin Engineering Company in the United States and/or other countries or regions may be designated with the “TM” and “SM” symbols. Brands, trademarks, and names of other parties, who may or may not be affiliated with, connected to, or endorsed by Martin Engineering Company, are identified wherever possible. Additional information regarding Martin Engineering Company’s intellectual property can be obtained at [www.martin-eng.com/trademarks](http://www.martin-eng.com/trademarks).*

# **Problem Solved™** ***GUARANTEED!***

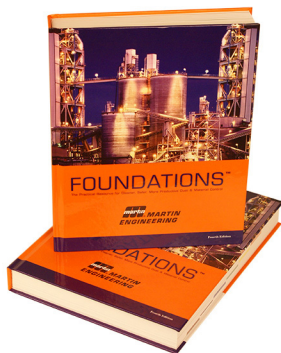

*For nearly 20 years, Martin Engineering's Foundations™ Books have taught industry personnel to operate and maintain clean and safe belt conveyors. The Foundations™ Book, fourth edition, focuses on improving belt conveyors by controlling fugitive material. "The Practical Resource for Total Dust and Material Control," is a 576-page hard cover volume that provides information of value to industries where the efficient handling of bulk materials is a key to productivity and profitability.*

*Expanding upon the book, our Foundations™ Training Program addresses the design and development of more productive belt conveyors, and is offered in three customizable seminars. Attendees gain a better understanding of conveyor safety and performance, helping to justify upgrade investments and increase profitability.*



## **Martin Engineering USA**

One Martin Place  
Neponset, IL 61345-9766 USA  
800 544 2947 or 309 852 2384  
Fax 800 814 1553  
[www.martin-eng.com](http://www.martin-eng.com)

**COMPANY WITH  
QUALITY SYSTEM  
CERTIFIED BY DNV  
= ISO 9001:2008 =**