



# MARTIN<sup>®</sup> XHD Spring Tensioner



**Installation Manual M3713UK**



<b>I</b>	<b>Contents .....</b>	<b>1</b>
<b>1</b>	<b>Introduction .....</b>	<b>3</b>
1.1	About this Installation Manual .....	3
1.1.1	Scope .....	3
1.1.2	Copyright .....	3
1.1.3	Disclaimer .....	3
1.1.4	Reference to additional documentation .....	4
1.1.5	Classification of hazards.....	5
1.2	Appropriate Use .....	6
1.2.1	Conveyor belt systems with open transfer systems .....	6
1.2.2	Use in EX-protection areas .....	6
1.2.3	Operating limits of this product .....	6
1.3	Safety at work .....	7
1.3.1	Safety instructions, safety at work .....	7
1.3.2	Obligations of the operator .....	7
1.3.3	Authorised personnel .....	7
<b>2</b>	<b>Description of this product .....</b>	<b>9</b>
2.1	Construction and function .....	9
2.2	Conveyor belt scraper .....	10
<b>3</b>	<b>Installation preparation .....</b>	<b>11</b>
3.1	Before installation.....	11
3.1.1	Required Materials and Tools .....	11
3.1.2	Preparatory measures .....	11
<b>4</b>	<b>Installation .....</b>	<b>13</b>
4.1	Safety instructions.....	13
4.2	Installation procedure.....	14
4.2.1	Determining the installation position of the conveyor belt scraper .....	15
4.2.2	Determining the installation position of the MARTIN® XHD Spring Tensioner .....	15
4.2.3	Installation of the conveyor belt scraper .....	19
4.2.4	Spring Tensioner Installation .....	20
4.2.5	Centre Scraper .....	22
4.2.6	Tension Spring Tensioner .....	22
4.3	Test run .....	26
4.4	Installations - Check-list .....	27
4.5	Attaching the warning label or the warning tag .....	28
<b>5</b>	<b>Maintenance .....</b>	<b>29</b>
5.1	Safety instructions.....	29
5.2	Weekly maintenance .....	29
<b>6</b>	<b>Troubleshooting .....</b>	<b>31</b>
6.1	Safety instructions.....	31
6.2	Troubleshooting .....	31
<b>7</b>	<b>Storage, De-installation, Disposal .....</b>	<b>33</b>
7.1	Storage.....	33
7.2	De-installation .....	33

7.3	Disposal .....	33
<b>8</b>	<b>Part numbers .....</b>	<b>35</b>
8.1	MARTIN® XHD Spring Tensioner .....	35
8.2	Mounting Brackets .....	35
8.3	MARTIN® Inspection Doors .....	35
8.4	Operating Instructions .....	36
8.5	Warning label / Warning tag.....	36
5.1	MARTIN® XHD Spring Tensioner .....	37
8.6	MARTIN® XHD Spring Tensioner-Dual .....	38
8.7	Warning and Product Labels.....	39
<b>9</b>	<b>Declaration of Incorporation .....</b>	<b>43</b>
<b>10</b>	<b>Notice .....</b>	<b>45</b>

# 1 Introduction

---

## 1.1 About this Installation Manual

Non-compliance to this installation manual can lead to the loss of any liability claim and/or guarantee.

### 1.1.1 Scope

This installation manual is exclusively for the product that is described herein, and is aimed at those people, that install the product, take the product into operation, and monitor its use.

### 1.1.2 Copyright

The product described and this installation manual are protected by copyright. Copying without a license will be legally prosecuted. All rights to this document are reserved, including the reproduction and/or distribution in any thinkable way or form. The reprinting of this document is only allowed with written permission from Martin Engineering.

The technical standard at the time of delivery of the product and technical documentation is decisive, as long as no other information is given. We reserved the right to make technical changes without any announcement. Earlier documents will no longer be valid. Martin Engineering General Conditions of Sale and Delivery apply.

### 1.1.3 Disclaimer

Martin Engineering guarantees the faultless operation of the product according to the advertising, edited product information, and technical documentation. Martin Engineering does not accept any liability for the efficiency and proper operation, if this product is used for any other purpose, other than as described in the section "Appropriate Use"; or for any damage caused by the use of accessories and/or spare parts, that were not delivered and/or certified by Martin Engineering.

The products from Martin Engineering are designed for a long service life. They correspond to state-of-the-art scientific and technology standards and were thoroughly inspected before delivery. Additionally, Martin Engineering carries out continuous product and market research for the further development of products.

In the event of faults and/or technical problems Martin Engineering offers professional support. Appropriate steps will be taken immediately. Martin Engineering's warranty conditions apply, which can be sent if required.

**1.1.4****Reference to additional documentation**

The following documents are referred to in this installation manual:

- Martin Inspection door M3127
- MARTIN® DURT TRACKER™ XHD Pre-Cleaning and Main Scraper Part no. M3706 and M3707
- MARTIN® QC™ #1 XHD Pre-Cleaning Scraper, Part no. M3504
- MARTIN® QC™ #1 XHD Metal-Tipped Pre-Cleaning Scraper, Part no. M3722

The following standards and guidelines were applied when composing this installation manual:

- EU Machinery Directive (2006 / 42 / EG)
- ISO/IEC Guide 37 "Installation instructions for end-consumer used products", edition 1995
- DIN 1421 "Structure and numbering in texts", edition 1983-01
- DIN/EN 12100-1 "Safety of machinery - Basic concepts, general principles of design", edition 2013-08
- DIN/ISO 16016 "Technical product documentation - Protection notices for restricting the use of documents and products", edition 2002-05
- DIN/EN 60204-1 "Safety of machinery - Electrical equipment of machines, Part 1, General requirements", edition 1998-11
- DIN EN 82079-1 "Preparation of instructions for use - Structuring, content and presentation - Part 1: General principles and detailed requirements".

## 1.1.5

## Classification of hazards

**DANGER!**

Stands for an imminent threat which will lead to serious physical injury or death if not avoided.

**WARNING!**

Stands for a possibly dangerous situation which could lead to serious physical injury or death if not avoided.

**CAUTION!**

Stands for a possibly dangerous situation which could lead to minor physical injury and/or damage to property if not avoided.

**NOTE**

Contains information to the installation or use of the product and points to situations, that cause neither injuries nor property damage, but is nevertheless important information.

## 1.2

### Appropriate Use

The MARTIN® XHD Spring Tensioner has been developed exclusively for use on the MARTIN® XHD Conveyor Belt Scrapers.

It is mounted on the main frame of this conveyor belt scraper and tensions this with a defined contact pressure against the conveyor belt to be cleaned. The spring tensioner can be used for a belt width of up to 3000 mm and a belt speed of up to 6 m/s.

Any other use of this product is deemed to be inappropriate. If you would like to use the MARTIN® XHD Spring Tensioner for any other purpose, please contact Martin Engineering Customer Service. We will be happy to assist you with product configuration.

### 1.2.1

#### Conveyor belt systems with open transfer systems

This installation manual describes the installation on conveyor belt systems with an encapsulated delivery system. For the installation on an open delivery systems different MARTIN® installation consoles can be used.

If installation conditions prove to be difficult, as is the case with impassable static components, or using the head drum as the tension point, Martin Engineering or a representative can help with the positioning or find customised solutions.

### 1.2.2

#### Use in EX-protection areas

The MARTIN® XHD Spring Tensioner can, under certain conditions, also be used in potentially explosive areas. Contact Martin Engineering for more information on use in potentially explosive areas.

The use of the spring tensioner in a device protection category that is higher than that specified or under conditions other than those specified by Martin Engineering is not permissible or may be done only if Martin Engineering has expressly granted approval for this purpose.

### 1.2.3

#### Operating limits of this product

The use of this named product is only allowed within the specified specifications. Using in a higher than specified equipment category or under operational conditions other than those named and specified previously by Martin Engineering, is considered to be inappropriate use and can only be carried out if approved by Martin Engineering.

If the MARTIN® XHD Spring Tensioner is to be used for any other purpose, Martin Engineering or a representative thereof can help with product configuration.



## 1.3 Safety at work

### 1.3.1 Safety instructions, safety at work

This installation manual should be read through completely before beginning work on the product or the customer's conveyor belt system.

The operator has to make sure that all installation, inspections, and maintenance tasks are carried out exclusively by authorised experts.

Basically, all work on conveyor belt systems and their accessories has to be done when the system is at a standstill. The instructions in the relevant installation manual, which describes how to shut-down the conveyor belt system, must be adhered to.

Upon completion of work, all safety equipment and protective guards should be reinstalled and put back into operation.

Before commissioning the installation should be completed. Before the conveyor belt system can be used again, the flawless execution of all steps should be checked. All notes on installation and commissioning of the product should be observed.

### 1.3.2 Obligations of the operator

The operator of this product must ensure that it is installed, maintained and used only by personnel who

- know the rules for safety and accident prevention,
- are instructed in the product's use, and have read and understood this installation manual.

### 1.3.3 Authorised personnel

Personnel are considered to be authorised, that have necessary training, technical experience, knowledge on the relevant standards and guidelines and are also in a position to assess any task to recognise critical situation at an early phase.

#### **Operational and Maintenance and Installation Personnel**

Personnel are considered to be authorised, that have been instructed in the use of the product and have completely read and understood this installation manual.

# Introduction

## 2 Description of this product

---

### 2.1 Construction and function

The MARTIN® XHD Spring Tensioners (XHD = eXtra Heavy Duty) have been specially developed for the scrapers MARTIN® DURT TRACKER™ XHD Pre-Cleaning and Main Scraper, the MARTIN® QC™ #1 XHD Pre-Cleaning Scraper and the MARTIN® QC™ #1 XHD Metal-Tipped Pre-Cleaning Scraper.

We differentiate between two types of MARTIN® XHD Spring Tensioners:

MARTIN® XHD Spring Tensioner, Part no. 38003+E

MARTIN® XHD Air Tensioner, Part no. 32135.



#### NOTE

A poorly or incorrectly installed product can hinder the conveyance process or contaminate the material to be conveyed.

The operator is therefore responsible for implementing necessary countermeasures.

In the case of application with contaminants, Martin Engineering or a representative can help with positioning or offer special solutions.



#### NOTE

In this operating manual, the installation of the MARTIN® XHD Spring Tensioner is described.

## 2.2

**Conveyor belt scraper**

The XHD Conveyor Belt Scrapers (XHD = eXtra Heavy Duty) are designed for the toughest of applications.

Thus, the XDH Conveyor Belt Scrapers can be used on conveyor belts with a belt width of up to 3000 mm and a belt speed of up to 6 m/sec. The installation position of the pre-cleaning scraper on the head drum and that of the main scraper just after the head drum ensures that the cleaned material is delivered back into the material flow.

Pre-cleaning and main scrapers can be each be used individually. For optimal cleaning results, however, it is recommended that a system consisting of pre-cleaning scraper and main scraper be installed.

The MARTIN® XHD Spring Tensioner may be used exclusively with the following conveyor belt scrapers:

- MARTIN® DURT TRACKER™ XHD Pre-Cleaning Scraper
- MARTIN® DURT TRACKER™ XHD Main Scraper
- MARTIN® QC™ #1 XHD Pre-Cleaning Scraper
- MARTIN® QC™ #1 XHD Metal-Tipped Pre-Cleaning Scraper

**NOTE**

You can find information regarding function and installation of the conveyor belt scrapers in the respective operating manuals, which are provided in the Part Numbers section.

## 3 Installation preparation

---

### 3.1 Before installation

#### 3.1.1 Required Materials and Tools

Exclusively standard tools are required for installation and maintenance of the MARTIN® XHD Spring Tensioner.

#### 3.1.2 Preparatory measures



##### NOTE

Pay attention to the following checks and carry them out completely.

The freight forwarder is responsible for any transport damage! For any damage claims, please contact the freight forwarder.

1. At delivery, check the following points:
  - Is the delivery complete? Is the number of palettes / cases / containers the same as the number on the delivery note?
  - Does all the transport packaging appear to be undamaged? Is there damage which may indicate that the contained products may be damaged?
2. If the delivery is incomplete or there is damage resulting from transportation, it is absolutely necessary to document this and have it confirmed by the freight forwarder. All damaged products should be saved for inspection.
3. The delivery should, depending on the scope of the order, contain the following parts:
  - One (in the case of single spring tensioners) or two (in the case of dual spring tensioners) MARTIN® XHD Spring Tensioner(s).
  - Screw assembly set for MARTIN® XHD Spring Tensioner.
  - Any mounting accessories included in the order.
  - One (single) or two (dual) label(s) "XHD Spring Tensioner (Main Scraper)", Part no. 36055-XXG.
  - Two pinch point warning labels, Part no. 30528G.
4. Martin Engineering and/or the authorised dealer are to be informed of any missing or damaged parts.



## 4 Installation

---

### 4.1 Safety instructions



#### NOTE

Read this section thoroughly before beginning any work!



#### WARNING! DANGER OF INJURY!

Body parts and/or clothing can be dragged in by rotating components or the moving conveyor belt.

*Before any installation or maintenance work is carried out, ensure that all power sources to the conveyor belt system and its accessories are switched off and secured against inadvertent reactivation. Use warning signs!*



#### WARNING! EXPLOSION HAZARD!

In enclosed areas there is an increased risk of explosion when using a cutting torch or welding equipment!

*Before use, check the level of gas and dust in the air.*

4.2

**Installation procedure**

The position of the MARTIN® XHD Spring Tensioner must be determined on both sides of the chute wall. Here, the positions on the chute wall at which the MARTIN® XHD Spring Tensioner is to be installed are determined.

The Martin Spring Tensioner is delivered in conjunction with a scraper. The scraper and the spring tensioner are delivered in disassembled form from the factory and installed in parallel.

An installation description for the MARTIN® XHD Spring Tensioner is included in the present installation manual. The remaining steps are described in the installation manual of the respective scraper.

Following is an overview of the installation steps:

No.	Installation step	Instruction
1	Determining the installation position of the conveyor belt scraper	Scraper
2	Determining the installation position	M3713
3	Installation of the scraper	Scraper
4	Installation of the Spring Tensioner	M3713
5	Tensioning the blade	M3713

Tab. 1: Installation steps

During installation, various on-site conditions requiring various steps may be present. These are as follows:

Installation on an encapsulated delivery system

- Carry out the instructions according to 4.2.1.

Installation on an encapsulated delivery system with installation opening and support for the conveyor belt scraper is already present.

- Carry out the instructions in 4.2.2.

Installation on an open delivery system

- Use the local resources to ensure that the dimensions for the installation are correctly maintained.

1. Prior to commencing installation, switch off and de-energise the conveyor belt system and all accessories and secure them against being switched on inadvertently.



**4.2.1 Determining the installation position of the conveyor belt scraper**

Pay attention to the relevant instructions for installation of the scraper in the respective operating instructions of the scraper used. (See section 1.1.4).

**4.2.2 Determining the installation position of the MARTIN® XHD Spring Tensioner**

**Prepare the MARTIN® XHD Spring Tensioner for installation**



**NOTE**

Martin Engineering recommends for improved maintenance and repair access the installation of a MARTIN® inspection door.



**NOTE**

When the spring tensioner is installed on a main scraper, the tension value label attached by the manufacturer (1) must be replaced in the same position with the enclosed label showing the tension values for the main scraper. (See section 22 on page 40).

2. Pull the spring split pin from the holding bolt.

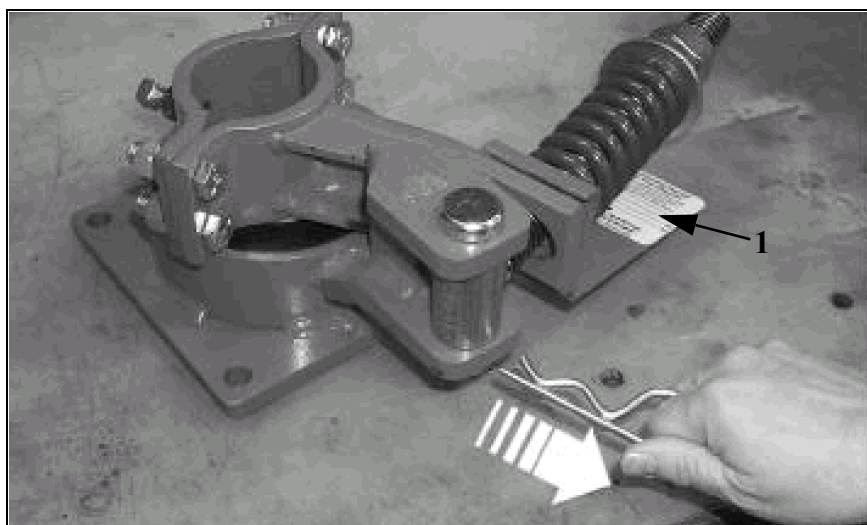

*Abb. 1: Remove spring split pin from holding bolt*

3. Pull out the holding bolt.



Abb. 2: Remove holding bolt

4. Take tensioning arm with spring and bracket out of the mounting plate.

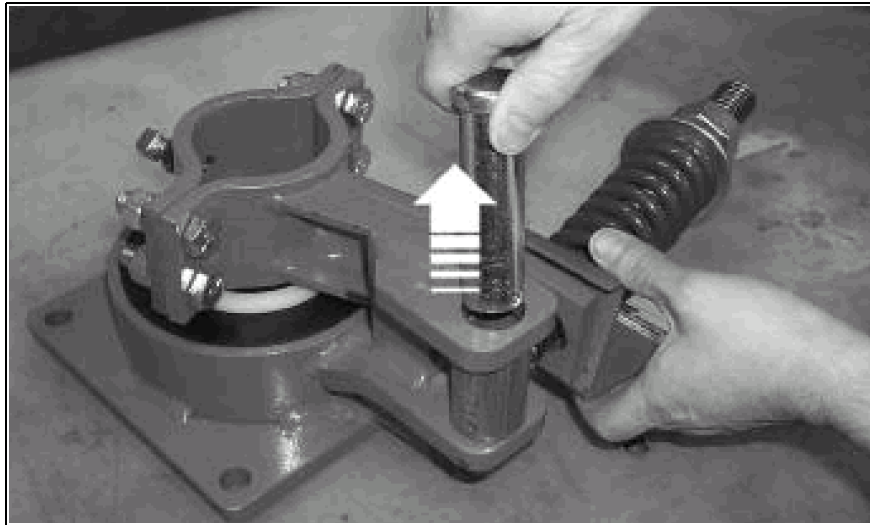

Abb. 3: Remove tensioning arm with spring

5. On the basis of the conveyor belt width and the installed conveyor belt scraper, check which tension value label has to be placed on the holder (1).

## Install Mounting Plates

The method for determining the position for the mounting plates on the chute wall is explained in the respective operating manual for the conveyor belt scraper being used.

1. Hold the mounting plates on the chute wall in such a way that the marking for the scraper axle is located directly in the centre of the axle opening.



Abb. 4: Mark the axle opening and screw holes

2. Mark the axle opening and the screw holes.



Abb. 5: Marked mounting openings



**WARNING! EXPLOSION HAZARD!**

In enclosed areas there is an increased risk of explosion when using a cutting torch or welding equipment!

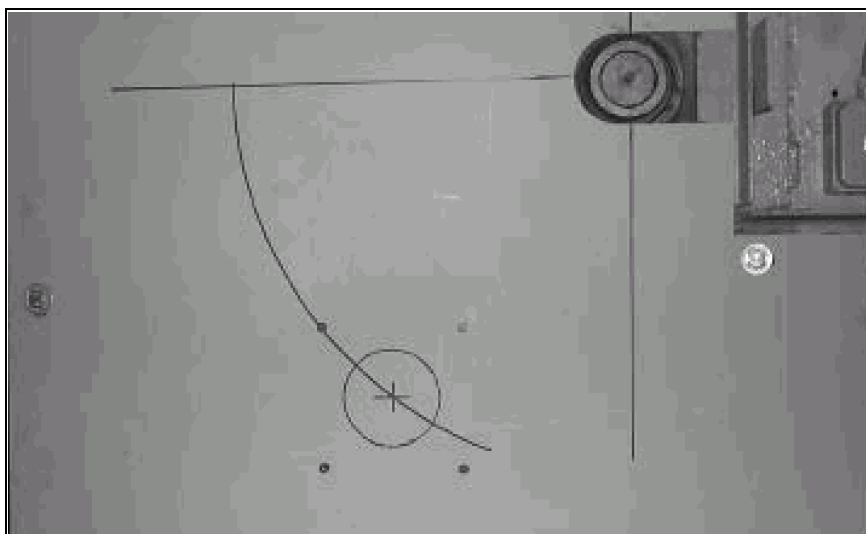
*Before use, check the level of gas and dust in the air.*

3. Create installation openings, e.g. by using a blow torch.



Abb. 6: Create mounting openings

4. Deburr the edges of the installation openings.

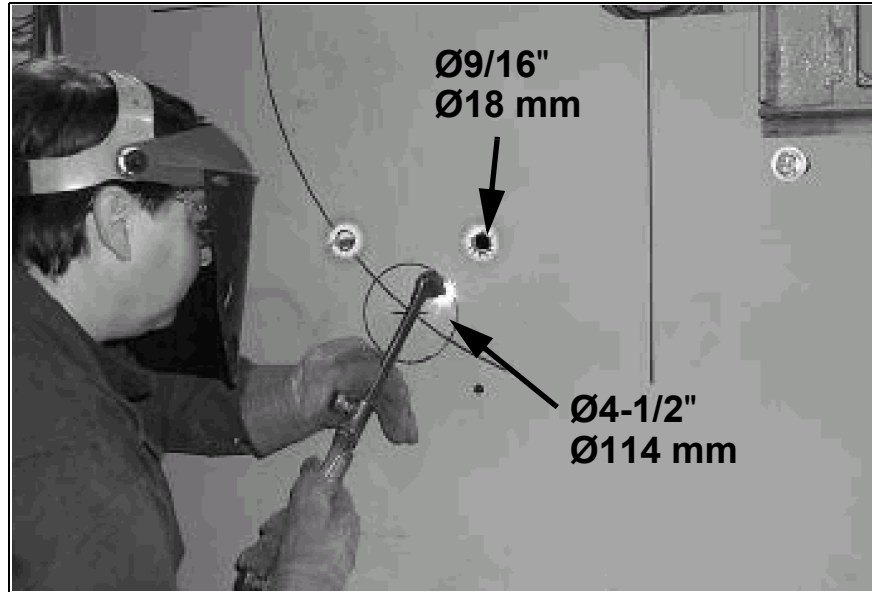

## NOTE

The mounting plates can be welded or screwed onto the chute wall. We recommend that mounting plates be screwed on for easier maintenance and access.

5. Screw the mounting plate with the arm for the spring mechanism on the operator's side.



Abb. 7: Mount the mounting plate on the operator's side

6. Fasten the nuts on the inner side of the chute.



*Abb. 8: Position nuts on inner side*

7. Install the other mounting plate on the opposite side of the chute.

#### 4.2.3

#### **Installation of the conveyor belt scraper**

Pay attention to the relevant instructions for installation of the scraper in the respective operating instructions of the scraper used. (See section 1.1.4).

4.2.4

Spring Tensioner Installation



**NOTE**

The tensioning arm of the spring tensioner must be installed, in the case of the pre-cleaning scraper, in the direction in which the conveyor belt moves. In the case of the main scraper, the arm should be installed in the opposite direction.



Abb. 9: Installation direction for the spring tensioner

1. Slide the tensioning arm onto the scraper axle.

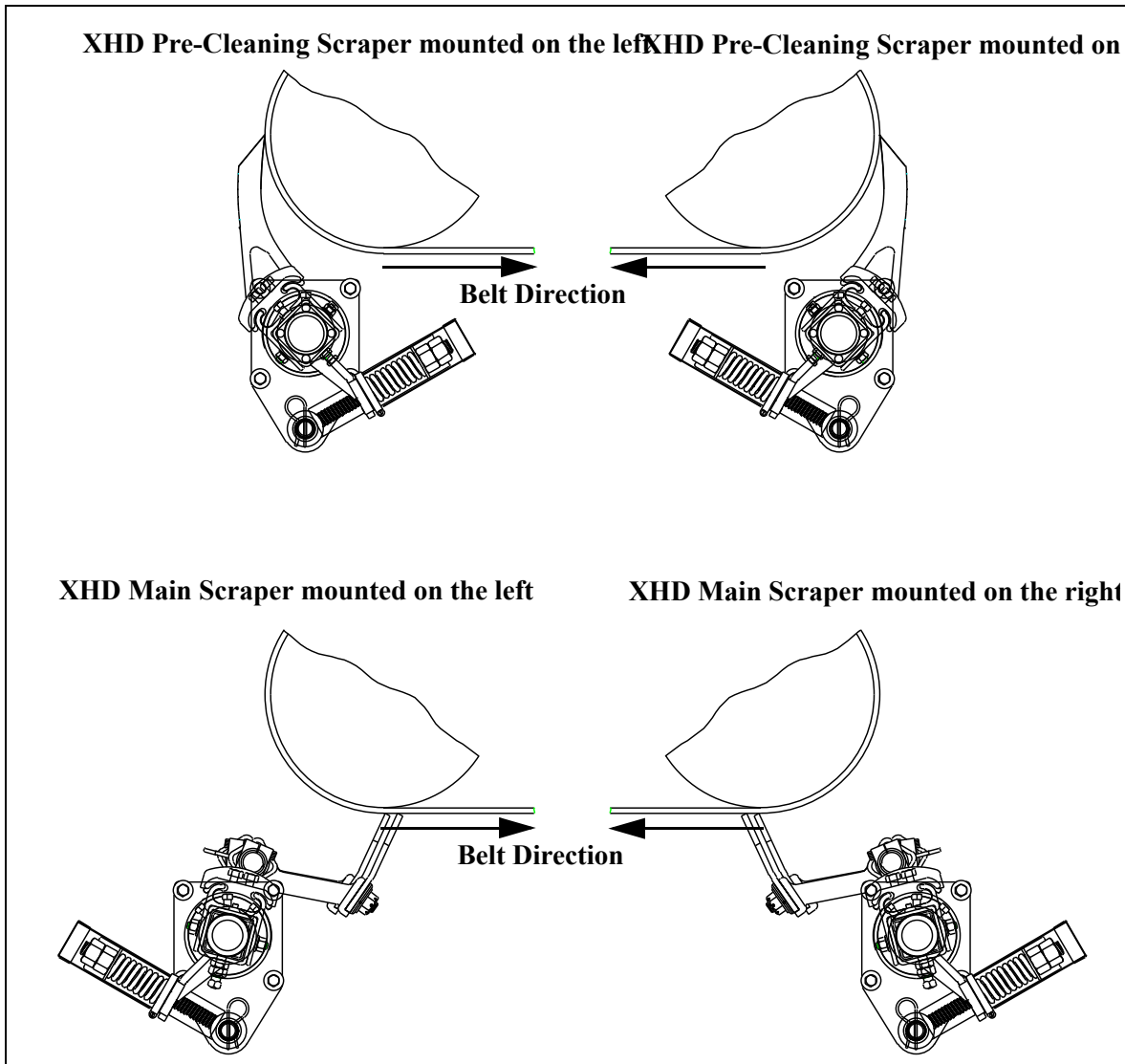

Abb. 10: Slide tensioning arm onto scraper axle

2. Thread the holding bolt through the boreholes of the holding arm and through the tensioning arm bush and secure with the holding bracket.

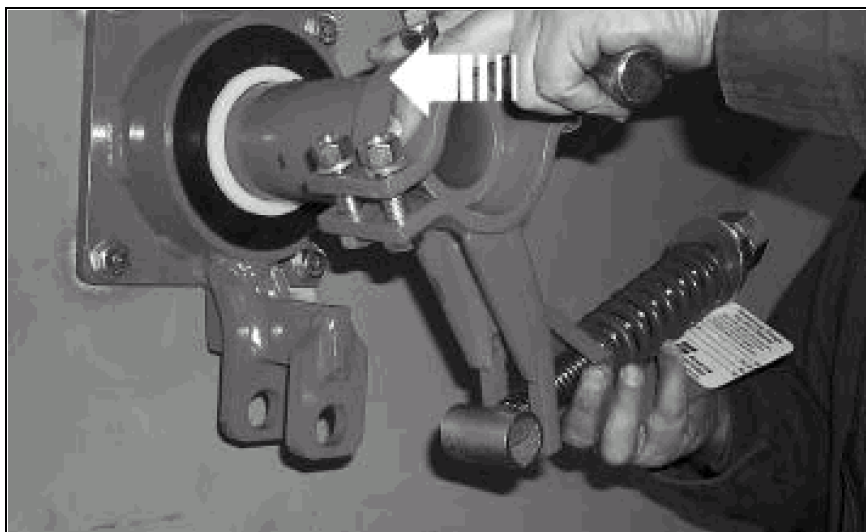

Abb. 11: Secure holding bolt

**4.2.5****Centre Scraper**

Pay attention to the relevant instructions for installation of the scraper in the respective operating instructions of the scraper used. (See section 1.1.4).

**4.2.6****Tension Spring Tensioner**

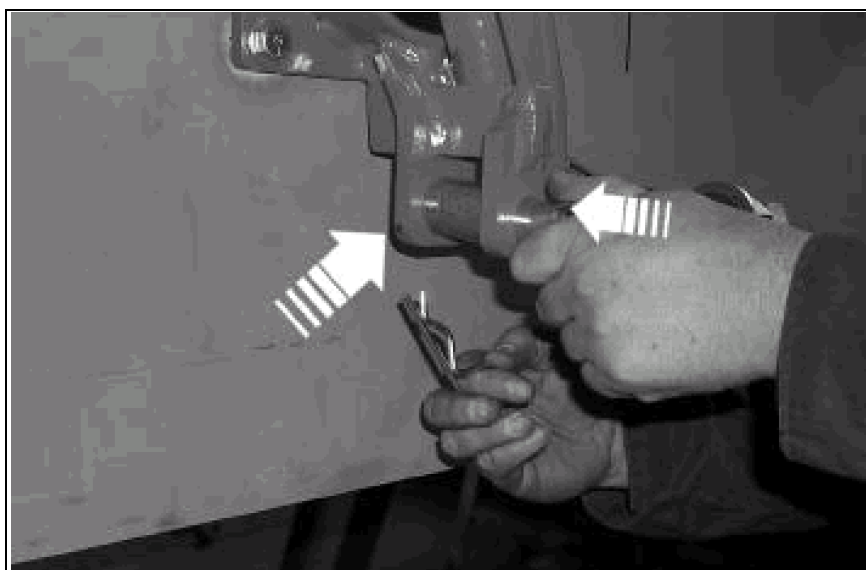
1. Remove the lock nut and unscrew the turnbuckle right up to the end of the thread in order to slacken the spring tensioner.

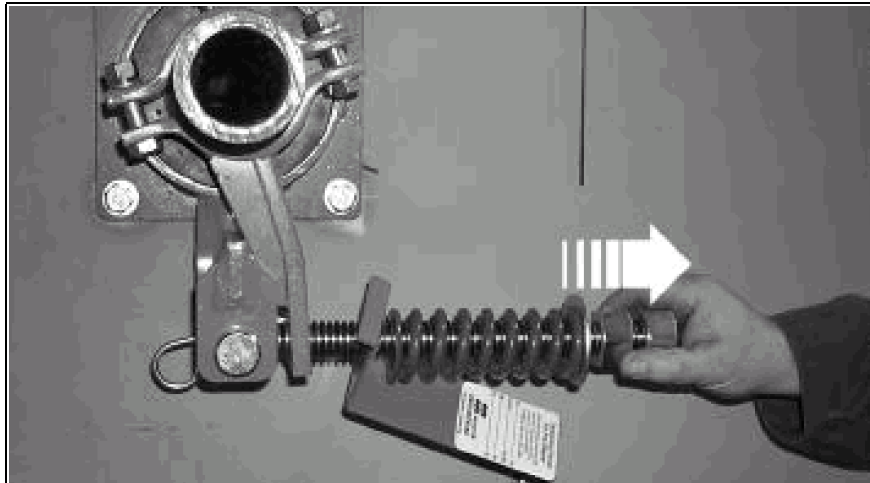

*Abb. 12: Slacken spring*

2. While a helper presses the scraper blades against the head drum, pull the tensioning arm as far up against the spring as possible.

**NOTE**

Both actions must be carried out at the same time.





Abb. 13: Tension spring tensioner

3. Firmly tighten all holding screws.

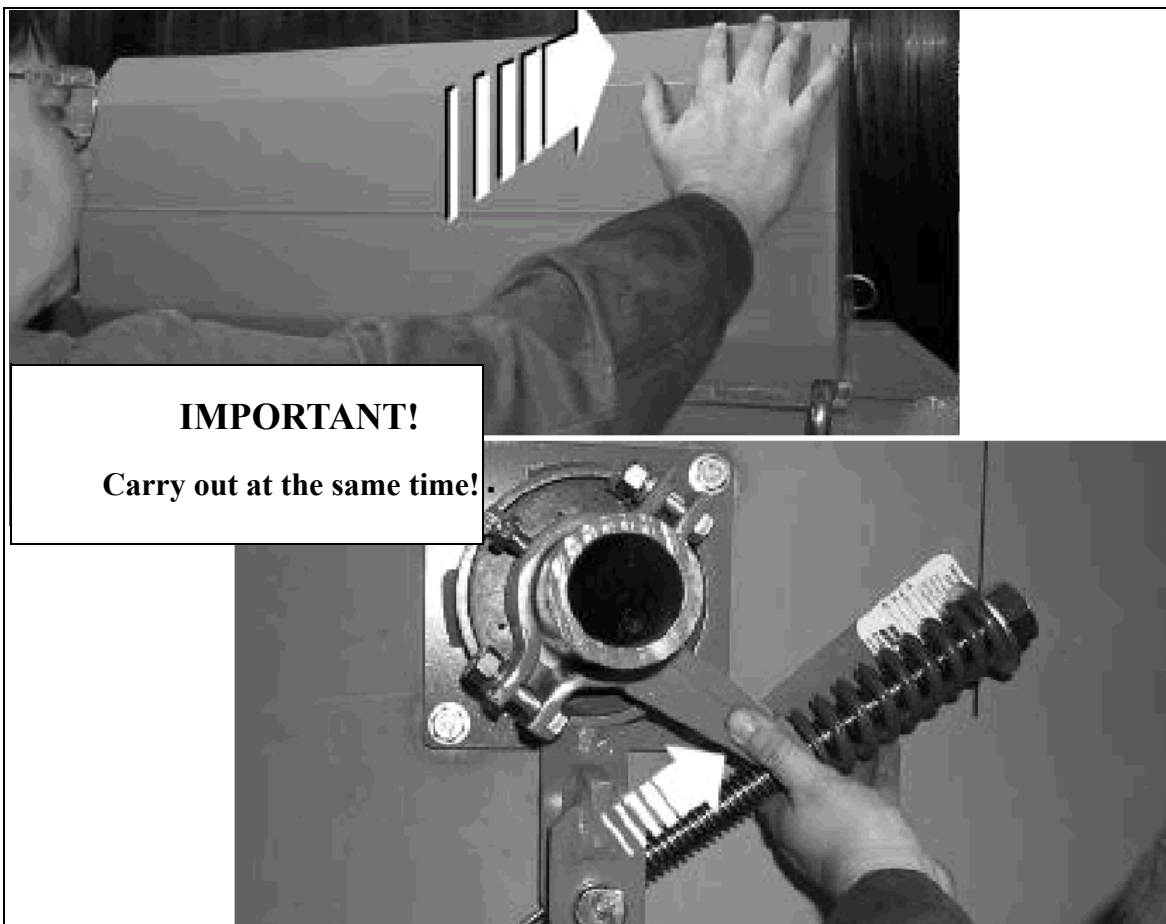

**NOTE**

When tightening, make sure to tighten all four holding screws and the adjusting screw!

4. Now screw tight the turnbuckle until the spring tension shown on the label has been reached.

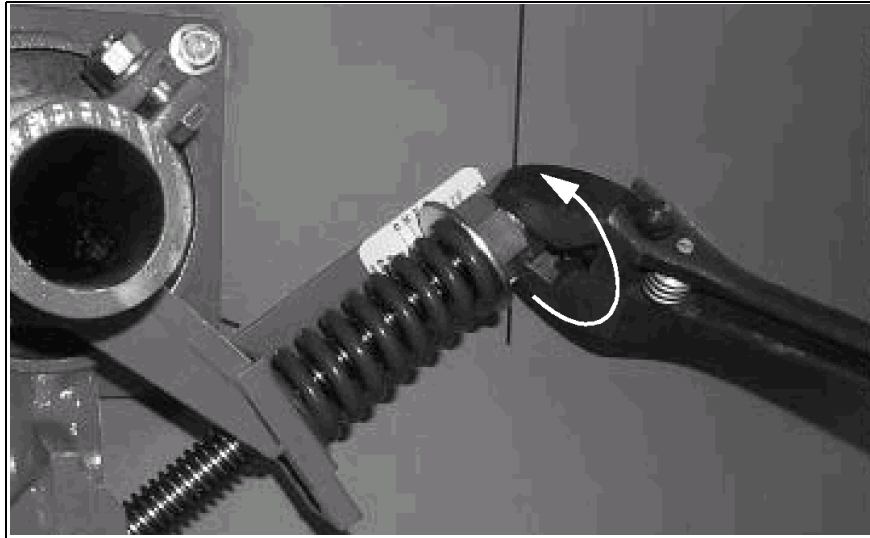

*Abb. 14: Adjust tension*

5. The washer marks the spring tension necessary for the belt width on the label scale.

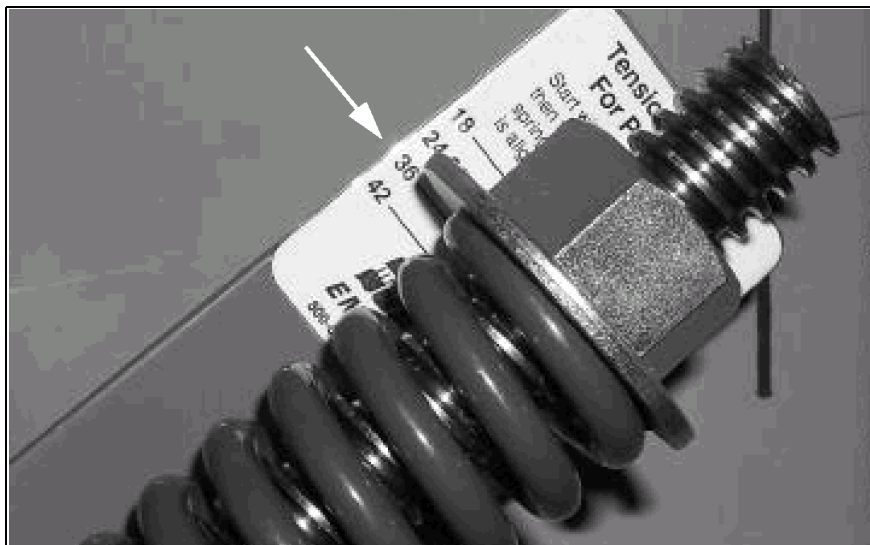

*Abb. 15: Adjust spring tension*

6. Now tighten the lock nuts. During tightening, the clamping nut must be held in place in order to avoid altering the adjusted spring tension.



Abb. 16: Lock clamping nut

## 4.3

## Test run

**NOTE**

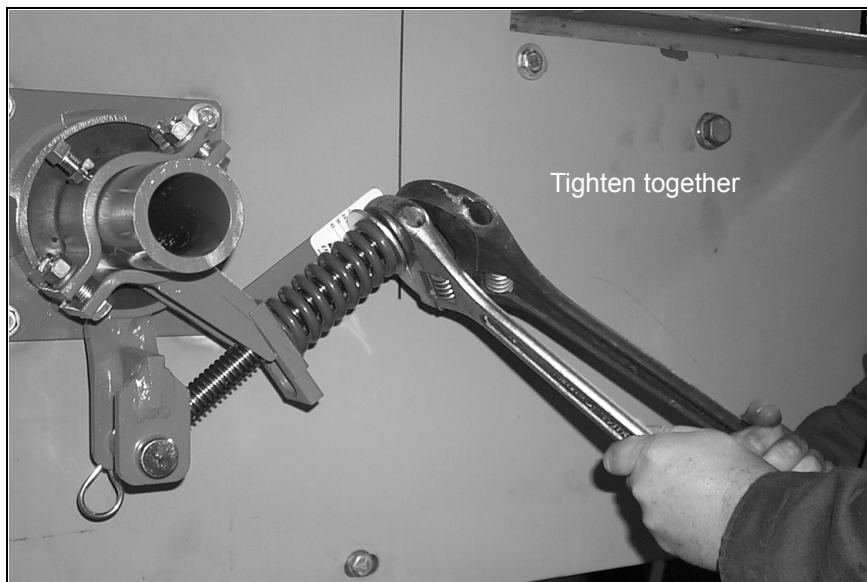
Read through this section thoroughly before starting any work on the conveyor belt scraper or the customer's conveyor belt system.

**CAUTION! FLYING PIECES!**

Tools or installation parts that are left behind can fall from a moving conveyor belt and cause slight injuries and property damage.

*After the installation first remove tools and installation parts from the conveyor belt before applying power.*

**WARNING! DANGER OF INJURY!**

Body parts and/or clothing can be dragged in by rotating components or the moving conveyor belt.

*Before any installation or maintenance work is carried out, ensure that all power sources to the conveyor belt system and its accessories are switched off and secured against inadvertent reactivation.*

*Use warning signs!*

1. Remove all tools and fire protection covers from the installation area and conveyor belt.
2. Carry out a one hour test run of the conveyor belt system.

**CAUTION! DANGER OF DAMAGE!**

Never operate the conveyor belt scraper for more than 15 minutes on the running and unloaded conveyor belt when it is fully tensioned. There is the risk of the conveyor belt scraper getting damaged and/or the conveyor belt getting damaged by overheating.

*Operate the conveyor belt scraper with full tension against the conveyor belt only when it is running and fully loaded.*

3. After the test run for an hour, shut down the conveyor belt system, switch off the power supply and secure it against being switched on again inadvertently.

4. Make sure that all securing parts are tightened. Tighten any loose connections.
5. Check the conveyor belt scraper for the following points:
  - **Wear and tear:** a little wear and tear is normal, as soon as the scraper blades have got adjusted to the contour of the conveyor belt, this stops happening.
  - **Material accumulation:** No material should have accumulated between the scraper blades and on the return side.
6. If the wear and tear or bulk material accumulation is excessive or other problems occur refer to the relevant instructions in the respective operating instructions of the conveyor belt scraper being used.

#### 4.4

#### Installations - Check-list

If the conveyor belt scraper does not work as expected after the test run, please observe and follow the instructions in the operating instructions of the respective conveyor belt scraper being used.

4.5

Attaching the warning label or the warning tag



Abb. 17: Warning label for conveyor belt products

## 5 Maintenance

### 5.1 Safety instructions

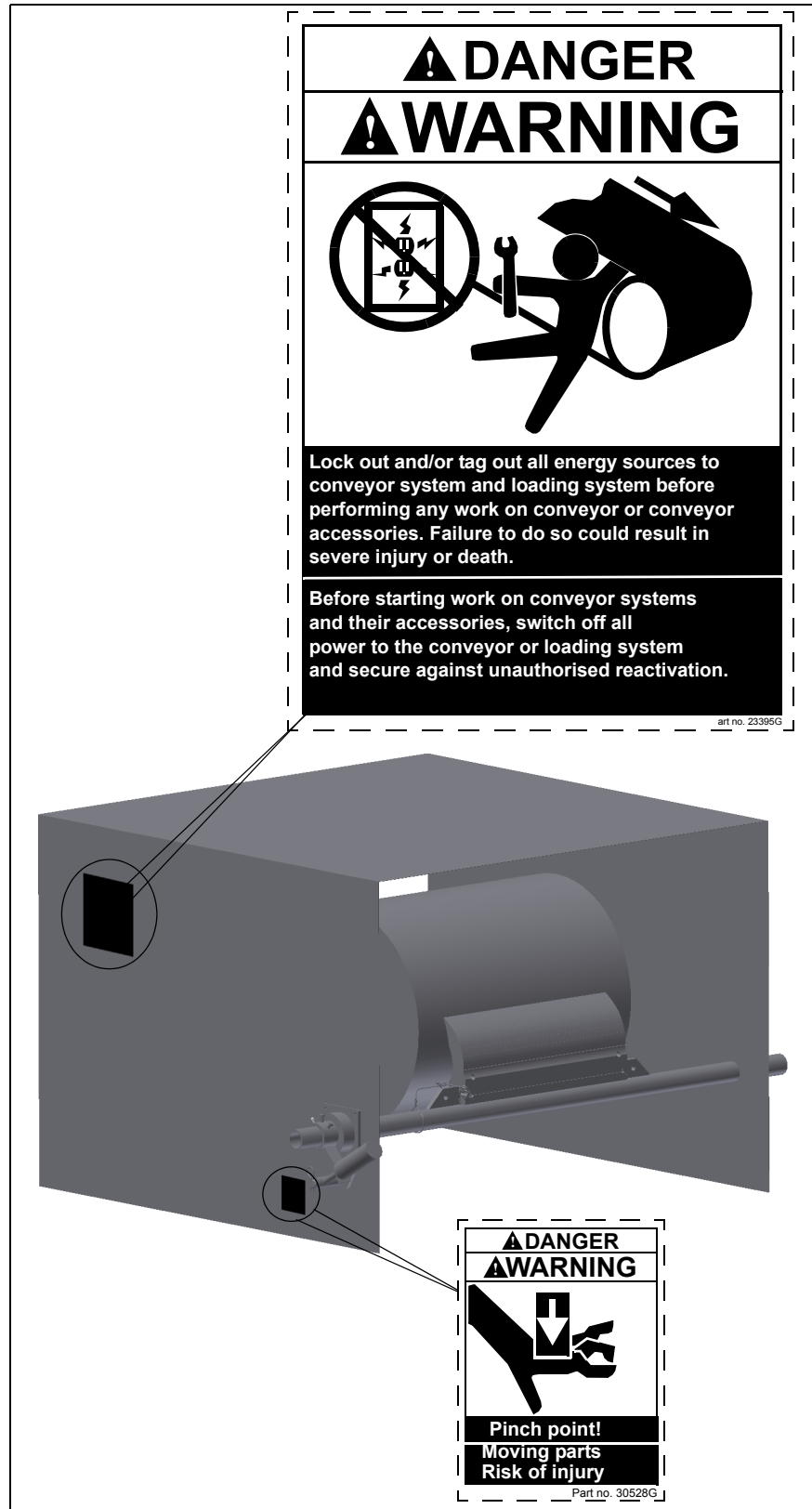

#### NOTE

Maintenance inspections should take place at least once a week. Depending on operational conditions, shorter maintenance intervals may be necessary.



#### NOTE

Read this entire section before you begin work of any kind.



#### WARNING! DANGER OF INJURY!

Body parts and/or clothing can be dragged in by rotating components or the moving conveyor belt.

*Before maintenance work is carried out, ensure that all power sources to the conveyor belt system and its accessories are switched off and secured against inadvertent reactivation.*

*Use warning signs!*

### 5.2 Weekly maintenance

1. Switch off the power supply of the conveyor belt and any other equipment and secure them against being switched on inadvertently.
2. Remove all material deposits from the scraper blade and the main axle.
3. Check that all securing parts are tightened. Tighten loose connections, if any.
4. Check the tension of the scraper and tighten it if necessary.



#### NOTE

If there are any signs of degrading operation, turn off the relevant part of the conveyor belt system. To receive support, contact Martin Engineering or a representative. DO NOT operate the conveyor belt system until the reason for the problem is known and a solution is found.



## NOTE

If the scraper blades are not cleaning effectively or have already been worn down by about a half, the tension of the spring tensioner must be readjusted.

5. Clean all warning labels. Replace any warning labels that cannot be read. Warning labels can be obtained from Martin Engineering or an authorised dealer.



## CAUTION! FLYING PIECES!

Tools or installation parts that are left behind can fall from a moving conveyor belt and cause slight injuries and property damage.

*After the installation first remove tools and installation parts from the conveyor belt before applying power.*

6. Relieve the spring tensioner of all tension and tension it once more until it reaches the given belt width on the label-scale.
7. Check the spring for any build-up of material and clean if necessary.
8. Spray the threaded rod with rust-inhibiting lubricant.
9. Remove all tools from the working area.
10. Switch on the conveyor belt system.



## WARNING! DANGER OF INJURY!

Body parts and/or clothing can be dragged in by rotating components or the moving conveyor belt.

*Do not touch or reach into the conveyor belt system and its accessories during its operation.*



## 6 Troubleshooting

### 6.1 Safety instructions



#### NOTE

Conveyor belt scrapers are subject to many different types of materials and are often used in extreme working and environmental conditions. Therefore faults can occur other than those listed here.

In such cases, Martin Engineering or a representative can help with positioning or offer special solutions. Use the conveyor belt system only after the fault has been identified and rectified.

### 6.2 Troubleshooting

If, after the installation, there is an abnormally high wear and tear on the scraper blades and/or the cleaning efficiency is too low, check the following points:

Symptom	Cause	Corrective action
High wear and tear on the scraper blades.	The scraper is fitted too tightly on the conveyor belt.	Decrease the tension. Please refer to the appropriate operating instructions for the spring tensioner for the values of tension.
Inadequate cleaning efficiency or material accumulation.	The scraper is fixed either too loosely or too tightly on the conveyor belt.	Increase or decrease the tension accordingly.
	The spring tensioner does not have any tension.	Either the cable is torn or the spring is broken. Replace the parts accordingly.
Noises or vibrations.	The scraper is fixed either too loosely or too tightly to the conveyor belt.	Adjust the tension if necessary.

Tab. 2: Troubleshooting



## 7 Storage, De-installation, Disposal

---

### 7.1 Storage

For your spring tensioner to work optimally, Martin Engineering recommends that you store the components in dry condition at room temperature and protect them from exposure to direct sunlight.

The best conditions for storage are at a temperature of +0°C to +30°C and 60% relative humidity.

### 7.2 De-installation

The de-installation is done in reverse sequence of the steps involved in installation (refer to section 4.2.2. page 20).

### 7.3 Disposal

Assemblies and/or spare parts of the Martin Engineering scraper should be disposed of properly after use.

- Complete assemblies should be de-installed and separated according to material and disposed of.

When disposing, all national and international waste disposal regulations have to be observed.

# Storage, De-installation, Disposal

## 8 Part numbers

---

In this chapter, the product terms along with the accompanying part numbers for the MARTIN® Spring Tensioner and accessories are listed.

When making orders, please always include the part number.

### 8.1 MARTIN® XHD Spring Tensioner

- MARTIN® XHD Spring Tensioner: Part no. 38003+E
- MARTIN® XHD Spring Tensioner - Dual:  
Part no. 38003-2+E

### 8.2 Mounting Brackets

- MARTIN® XHD Mounting Bracket - For mounting of the MARTIN® XHD Spring Tensioner on another structure, when no housing is present Part no. 32818+E

### 8.3 MARTIN® Inspection Doors

With standard rubber door, up to 177° C:

- 229 x 305 mm: Part no. CYAR-0912.
- 305 x 356 mm: Part no. CYAR-1214.
- 305 x 457 mm: Part no. CYAR-1218.
- 457 x 610 mm: Part no. CYAR-1824.
- 610 x 610 mm: Part no. CYAR-2424.

With steel door (dust-proof):

- 229 x 305 mm: Part no. CYA-0912.
- 305 x 356 mm: Part no. CYA-1214.
- 305 x 457 mm: Part no. CYA-1218.
- 457 x 610 mm: Part no. CYA-1824.
- 610 x 610 mm: Part no. CYA-2424.

**8.4**

**Operating Instructions**

- MARTIN® Inspection Door - Part no. M3127
- MARTIN® DURT TRACKER™ XHD Pre-Cleaning Scraper and Main Scraper - Part no. M3706 and M3707
- MARTIN® QC™ #1 XHD Pre-Cleaning Scraper - Part no. M3504
- MARTIN® QC™ #1 XHD Metal-Tipped Pre-Cleaning Scraper - Part no. M3722

**8.5**

**Warning label / Warning tag**

- Warning label for conveyor belt products: Part no. 30528

5.1

**MARTIN® XHD Spring Tensioner**



Abb. 18: MARTIN® XHD Spring Tensioner

Pos	Description	Part no.	Quantity
1	Casing	32322+E	2
2	Mounting flange	38001+E	1
3	Split pin	41566-41-60	2
4	Threaded rod	38002+E	1
5	Protective covering for spring	32245-04+E	1
6	Lever arm	37855+E	1
7	Pipe clamp	20339-11	1
8	Mounting case	36119+E	1
9	Spring 5"	35127+E	1
10	Washer 1"	32315	1
11	Hex. screw M12 x 45 DIN 933	41081-12045BZP88	8
12	Hex. screw M12 DIN 934	41086-12BZP	8
13	Washer A13 DIN 125	41088-12AZP	8
14	Spring ring A12 DIN 127	41090-12AZP	8
15	Clear pipe	34063-08+E	1
16	Protective cover	34054+E	1
17	Hexagonal nut 1"	32311-01+E	2
18	Square screw 1/2" - 13 NC x 1.00"	41444-12025BZP	5
19	Adjusting ring	32341-01+E	1
20	Counter plate	32342+E	1
21	Washer 1-1/4"	34672	1
22	Nylon bush	34306+E	2
nd	Holder for label "Tension Values"	36051+E	1

Tab. 3: Parts List - MARTIN® XHD Spring Tensioner

8.6

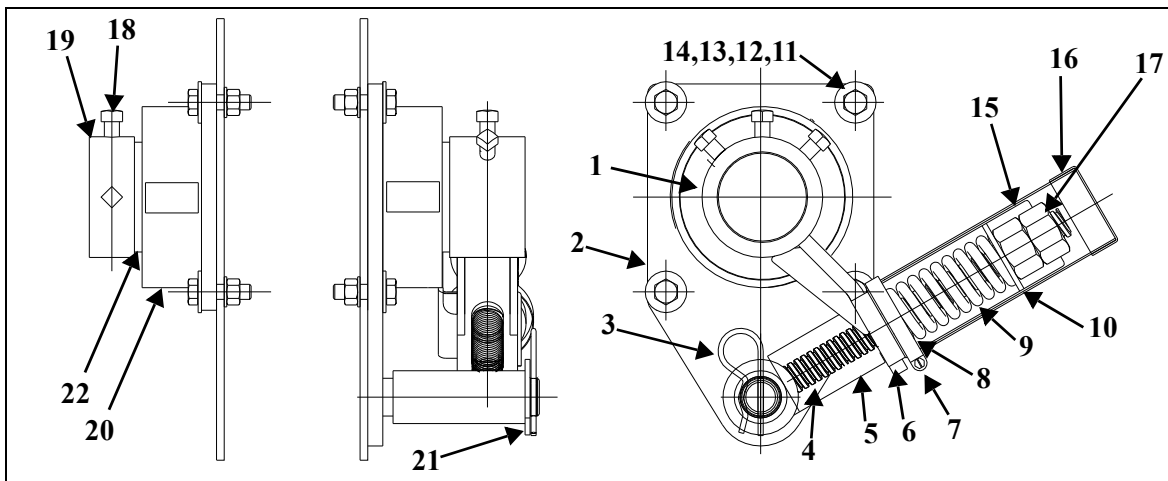
MARTIN® XHD Spring Tensioner-Dual



Abb. 19: MARTIN® XHD Spring Tensioner - Dual

Pos	Description	Part no.	Quantity
1	Casing	32322+E	2
2	Mounting flange	38001+E	2
3	Spring split pin	41566-41-60	2
4	Threaded rod	38002+E	2
5	Protective covering	32245-04+E	2
6	Lever arm	37855+E	2
7	Pipe clamp	20339-11	2
8	Mounting case	36119+E	2
9	Spring 5"	35127+E	2
10	Washer 1"	32315	2
11	Hexagonal screw M12 x 45	41081-12045BZP88	8
12	Hexagonal nut M12	41086-12BZP	8
13	Washer M12	41088-12AZP	8
14	Spring ring M12	41090-12AZP	8
15	Clear pipe	34063-08+E	2
16	Protective cover	34054+E	2
17	Hexagonal nut 1"	32311-01+E	4
18	Washer 1-1/4"	34672	2
19	Nylon bush	34306+E	2
20	Square screw 1/2" - 13 NC x 1"	41444-12025BZP	6
nd	Holder for label "Tension Values"	36051+E	2

Tab. 4: Parts List- MARTIN® XHD Spring Tensioner - Dual



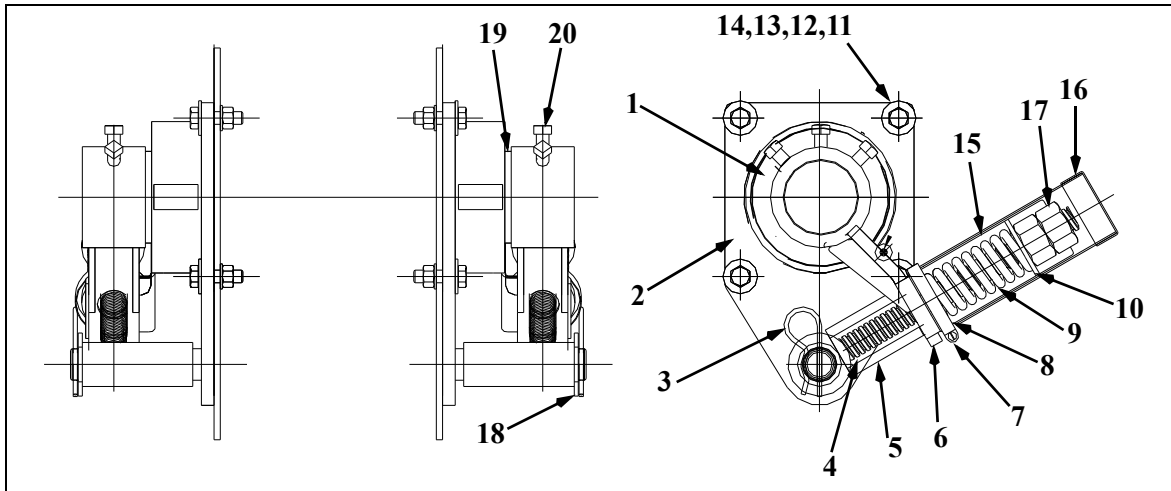



Abb. 20: Warning Label Crushing Hazard, Part no. 30528G

**Tension Measure-  
ments for Pre-**

Tension the scraper until the blades touch the belt. Then tension the spring until the disc is on the value for the belt width (in mm).

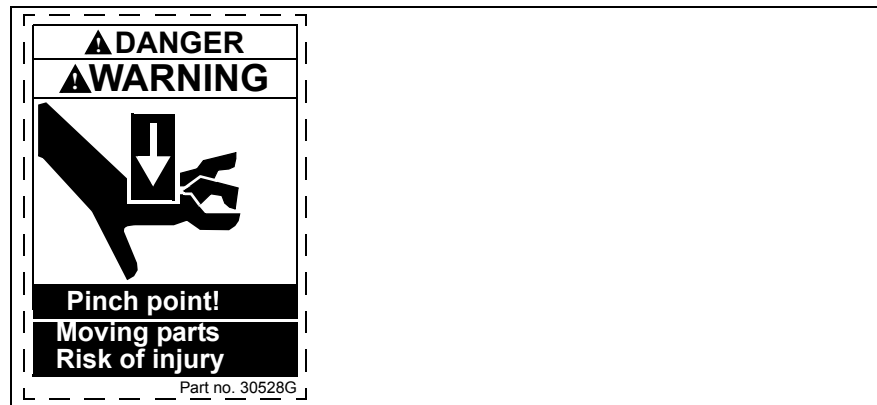
<b>500</b>	—————	<b>500</b>
<b>600-800</b>	—————	<b>600-800</b>
<b>1000</b>	—————	<b>1000</b>
<b>1200</b>	—————	<b>1200</b>



Tel.: (06123) 97 82 0  
Part No.: 36055-P1G

Abb. 21: Label Tension Values (Pre-Cleaning Scraper), Part no. 36055-P1G

**Tension Measure-  
ments for Pre-**

Tension the scraper until the blades touch the belt. Then tension the spring until the disc is on the value for the belt width (in mm).

Part No.: 36055-P2G

<b>1400-1600</b>	—————	<b>1400-1600</b>
<b>1800-2000</b>	—————	<b>1800-2000</b>
<b>2200-2400</b>	—————	<b>2200-2400</b>
<b>2600-3000</b>	—————	<b>2600-3000</b>



Tel.: (06123) 97 82 0

Abb. 22: Label Tension Values (Pre-Cleaning Scraper), Part no. 36055-P2G

**Tension Measurements for Main**

Tension the scraper until the blades touch the belt. Then tension the spring until the disc is on the value for the belt width (in mm).

Part No.: 36055-S1G

<b>500-600</b>	—————	<b>500-600</b>
<b>800</b>	—————	<b>800</b>
<b>1000</b>	—————	<b>1000</b>
<b>1200</b>	—————	<b>1200</b>



**MARTIN ENGINEERING**

Tel.:(06123) 97 82 0

Abb. 23: Label Tension Values (Main Scraper), Part no. 36055-S1G

**Tension Measurements for Main Scraper**

Tension the scraper until the blades touch the belt. Then tension the spring until the disc is on the value for the belt width (in mm).



**MARTIN ENGINEERING**

Tel.:(06123) 97 82 0

<b>1400-1600</b>	—————	<b>1400-1600</b>
<b>1800-2000</b>	—————	<b>1800-2000</b>
<b>2200-2400</b>	—————	<b>2200-2400</b>
<b>2600-2800</b>	—————	<b>2600-2800</b>
<b>3000</b>	—————	<b>3000</b>

Part No.36055-S2G

Abb. 24: Label Tension Values (Main Scraper), Part no. 36055-S2G

# Part numbers

The EC Declaration of Incorporation and incomplete machine with regards to the MARTIN® XHD Spring Tensioner is given below.



**EC - Declaration of Incorporation according to the Machinery Directive  
(2006/42/EC)**

**Annex II B for the installation of an incomplete machine**

We hereby declare, the company **Martin Engineering**  
In der Rehbach 14                      Tel.: +49 (0)6123-97820  
D-65396 Walluf                              Fax: +49 (0)6123-75533

that the following named product

Product designation:

**Spring tensioner for conveyor belt scraper**

the make / type of:

**MARTIN<sup>®</sup> XHD Spring Tensioner**

with the serial number:

**not required**

complies with the following provisions:

**EC - Machinery Directive 2006/42/EC  
DIN EN 618 - Equipment and systems for bulk goods**

In particular, the following harmonised standards have been applied:

**DIN EN ISO 12100 Safety of machinery  
DIN EN 349 - Safety of machinery - Crushing hazard**

Notified body:

**not required**

The information provided in the installation manual and technical documentation are in the original version with the named product.

The operation of this product is prohibited until it has been established that, the system in which it is to be installed complies with the provisions of the EU Directive 98/37/EC and 2006/42/EC in the amended form.

Date: 21/01/2010

Manufacturer's signature: Managing director, Michael Hengl



# ***PROBLEM SOLVED™***



**MARTIN ENGINEERING GMBH**

In der Rehbach 14  
65396 Walluf, Deutschland  
Phone +49 (0)6123 97820  
Fax +49 (0)6123 75533  
E-Mail: [info@martin-eng.de](mailto:info@martin-eng.de)  
[www.martin-eng.de](http://www.martin-eng.de)

Subject to technical modifications  
Quality Management System certified DNV - ISO 9001

