

***martin***®

# ***N2***® Gateway



***Operator's Manual***  
***M4152***

# Important

MARTIN ENGINEERING HEREBY DISCLAIMS ANY LIABILITY FOR: DAMAGE DUE TO CONTAMINATION OF THE MATERIAL; USER'S FAILURE TO INSPECT, MAINTAIN AND TAKE REASONABLE CARE OF THE EQUIPMENT; INJURIES OR DAMAGE RESULTING FROM USE OR APPLICATION OF THIS PRODUCT CONTRARY TO INSTRUCTIONS AND SPECIFICATIONS CONTAINED HEREIN. MARTIN ENGINEERING'S LIABILITY SHALL BE LIMITED TO REPAIR OR REPLACEMENT OF EQUIPMENT SHOWN TO BE DEFECTIVE.

Observe all safety rules given herein along with owner and Government standards and regulations. Know and understand lockout/tagout procedures as defined by American National Standards Institute (ANSI) z244.1-1982, *American National Standard for Personnel Protection - Lockout/Tagout of Energy Sources - Minimum Safety Requirements* and Occupational Safety and Health Administration (OSHA) Federal Register, Part IV, 29 CFR Part 1910, *Control of Hazardous Energy Source (Lockout/Tagout); Final Rule*.

The following symbols may be used in this manual:



**Danger:** Immediate hazards that will result in severe personal injury or death.



**Warning:** Hazards or unsafe practices that could result in personal injury.



**Caution:** Hazards or unsafe practices that could result in product or property damages.



**Important:** Instructions that must be followed to ensure proper installation/operation of equipment.



**Note:** General statements to assist the reader.

# Introduction

---

## General

The N2<sup>®</sup> Gateway receives information from up to 200 N2<sup>®</sup> Position Indicators and transmits information to the cloud for monitoring via the Martin<sup>®</sup> Smart Device Manager mobile application. The N2<sup>®</sup> Position Indicator monitors belt cleaner angle and indicates when a belt cleaner requires adjustment. The position indicator also alerts in the event of excessive belt cleaner movement. The N2<sup>®</sup> Position Indicator can be monitored and setup using the Martin<sup>®</sup> Smart Device Manager.

**Table I. N2<sup>®</sup> Gateway Specifications**

Power Supply	Power Consumption	Service Temperature Range
50/60 Hz 100-240 VAC	.75 Amps	-40 to 70°C (-22 to 140°F)

## References

The following documents are referenced in this manual:

- American National Standards Institute (ANSI) z244.1-1982, *American National Standard for Personnel Protection - Lockout/Tagout of Energy Sources - Minimum Safety Requirements*, American National Standards Institute, Inc., 1430 Broadway, New York, NY 10018.
- Federal Register, Volume 54, Number 169, Part IV, 29 CFR Part 1910, *Control of Hazardous Energy Source (Lockout/Tagout); Final Rule*, Department of Labor, Occupational Safety and Health Administration (OSHA), 32nd Floor, Room 3244, 230 South Dearborn Street, Chicago, IL 60604.

***Data Policy***

The N2® Gateway (“Product”) automatically collects and transmits to Martin Engineering (“we,” “us,” and “our”) information related to the Product and its operation, including data on consumable components, process parameters such as Product settings and configurations, and environment such as temperature and operating times and durations (the “Information”).

Martin Engineering uses the Information to:

- provide services to you, including identifying and providing preventative maintenance such as the replacement of consumable components;
- send communications we believe may be of interest to you;
- research and improve our products and services, including by aggregating and combining the Information with comparable information obtained from other Product owners;
- provide information regarding the Product (such as average replacement time for consumable components) to potential Product purchasers, provided that such information shall be provided only in aggregated, de-identified form; and
- share with select third parties in connection with any of the purposes above

Martin Engineering may also disclose any Information if: (1) the disclosure is necessary or useful to our provision of services; (2) we believe in good faith that disclosure is necessary to protect our rights, interests, or property; (3) we are acting in good faith to protect the safety of the Product owner or operator or the safety of others, to investigate fraud, or to respond to a government request; (4) we believe in good faith the disclosure is required by law, such as to comply with a subpoena, search warrant, court order, or similar legal or administrative process; and (5) a third party purchases or otherwise acquires our company, in which case the Information will likely be among the assets transferred.

By purchasing or using the Product, you consent to the collection and use of the Information by Martin Engineering. From time to time, we may use the Information for new, unanticipated uses not previously disclosed in this Data Policy. If our information practices change materially at some time in the future, we will post the policy changes to our website so you always have information regarding what information we collect, how we use it, and under what circumstances we disclose it. By continuing to use the Product after such changes, you consent to the changes in the Data Policy.

All safety rules defined in the above documents and all owner/employer safety rules must be strictly followed when working on the belt cleaner.



**⚠ DANGER**

Do not touch or go near the conveyor belt or conveyor accessories when the belt is running. Your body or clothing can get caught and you can be pulled into the conveyor, resulting in severe injury or death.



**⚠ DANGER**

Before installing, servicing, or adjusting conveyor equipment, turn off and lockout / tagout / blockout / testout all energy sources to the conveyor and conveyor accessories according to ANSI standards. Failure to do so could result in serious injury or death.

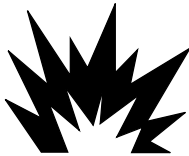

**⚠ DANGER**

If this equipment will be installed in an enclosed area, test the gas level or dust content before using a cutting torch or welding. Using a torch or welding in an area with gas or dust may cause an explosion resulting in serious injury or death. Follow local confined space procedures.



**⚠ WARNING**

Before using a cutting torch or welding the chute wall, cover the conveyor belt with a fire retardant cover. Failure to do so can allow the belt to catch fire. Follow local fire watch procedures.

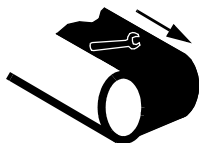

**⚠ WARNING**

Remove all tools from the installation area and conveyor belt before turning on the conveyor. Failure to do so can cause serious injury to personnel or damage to the belt and conveyor.

# Before Installing N2<sup>®</sup> Gateway

---

## IMPORTANT

The delivery service is responsible for damage occurring in transit. Martin Engineering CANNOT enter claims for damages. Contact your transportation agent for more information.

1. Inspect shipping container for damage. Report damage to delivery service immediately and fill out delivery service's claim form. Keep any damaged goods subject to examination.
2. Remove N2<sup>®</sup> Gateway from shipping container.
3. If anything is missing contact Martin Engineering or a representative.



## ⚠ DANGER

Before installing, servicing, or adjusting conveyor equipment, turn off and lockout / tagout / blockout / testout all energy sources to the conveyor and conveyor accessories according to ANSI standards. Failure to do so could result in serious injury or death.

4. Turn off and lockout / tagout / blockout / testout energy source according to ANSI standards (see "References").

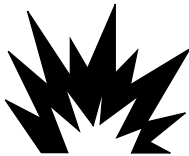

## ⚠ DANGER

If this equipment will be installed in an enclosed area, test the gas level or dust content before using a cutting torch or welding. Using a torch or welding in an area with gas or dust may cause an explosion resulting in serious injury or death.

5. If using a cutting torch or welding, test atmosphere for gas level or dust content. Cover conveyor belt with fire retardant cover.

## IMPORTANT

The N2<sup>®</sup> Gateway must be installed within 800m (2625 ft) of the N2<sup>®</sup> Position Indicators, but not closer than 3m (10 ft).

# Installing N2<sup>®</sup> Gateway

## **⚠ WARNING**

Before making any connections, lockout / tagout / blockout / testout electrical supply to according to ANSI standards (see “References”).

All electrical work must be done to National Electrical Code (NEC) standards.

## **⚠ CAUTION**

Do not mount N2<sup>®</sup> Gateway in area subject to shock, vibration, temperatures exceeding 70°C (140°F), or explosion. Damage to control panel circuitry could result.

1. Determine location for N2<sup>®</sup> Gateway. N2<sup>®</sup> Gateway should be mounted in an elevated location nearest the center of all position indicators.

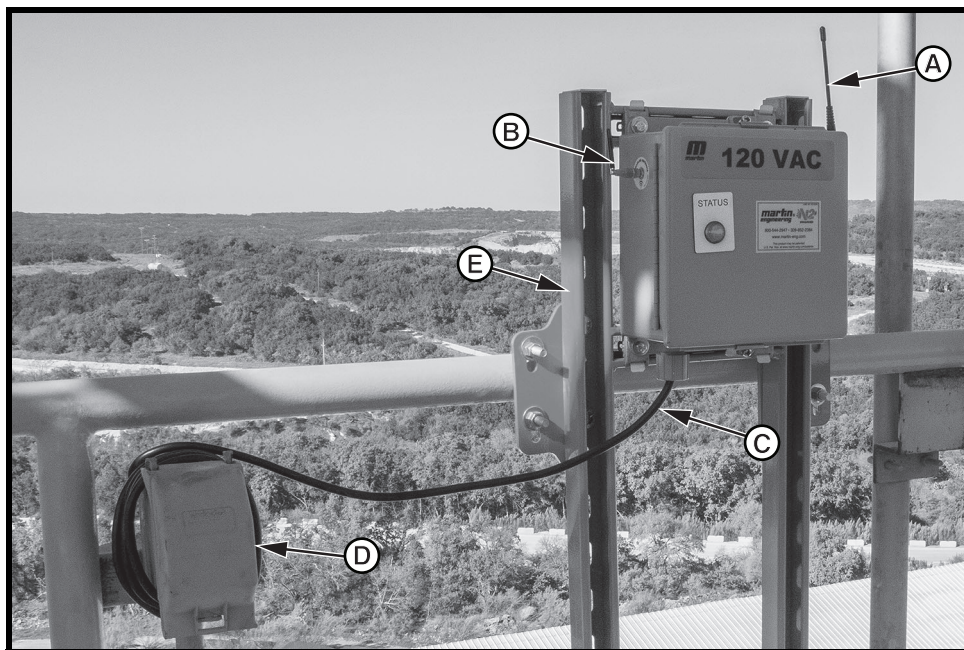

2. Mount N2<sup>®</sup> Gateway using supplied mounting bracket (E) and hardware.
3. Install long radio antenna (A).
4. Install either short cellular antenna or Wi-Fi antenna (B).
5. Using electrical conduit and connectors, route 120V power supply (D) to a location near the N2<sup>®</sup> Gateway.
6. Connect cord (C) from N2<sup>®</sup> Gateway to 120V power supply.
7. Power light will be illuminated if N2<sup>®</sup> Gateway is receiving AC power.



8. Scan qr code to download and install the Martin<sup>®</sup> Smart Device Manager App.
9. Contact [n2admin@martin-eng.com](mailto:n2admin@martin-eng.com) for login information.
10. Follow on screen instructions to register position indicator and complete installation.



# Part Numbers

This section provides product names and corresponding part numbers for the N2<sup>®</sup> Gateway and related equipment. Please reference part numbers when ordering parts.

## Part Numbers

N2<sup>®</sup> Gateway: P/N EGC006XXXXXXXXXX.

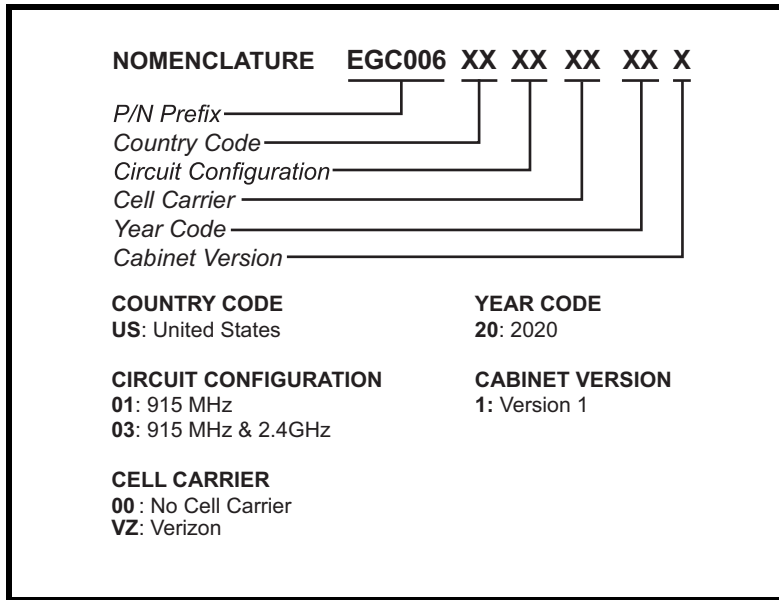

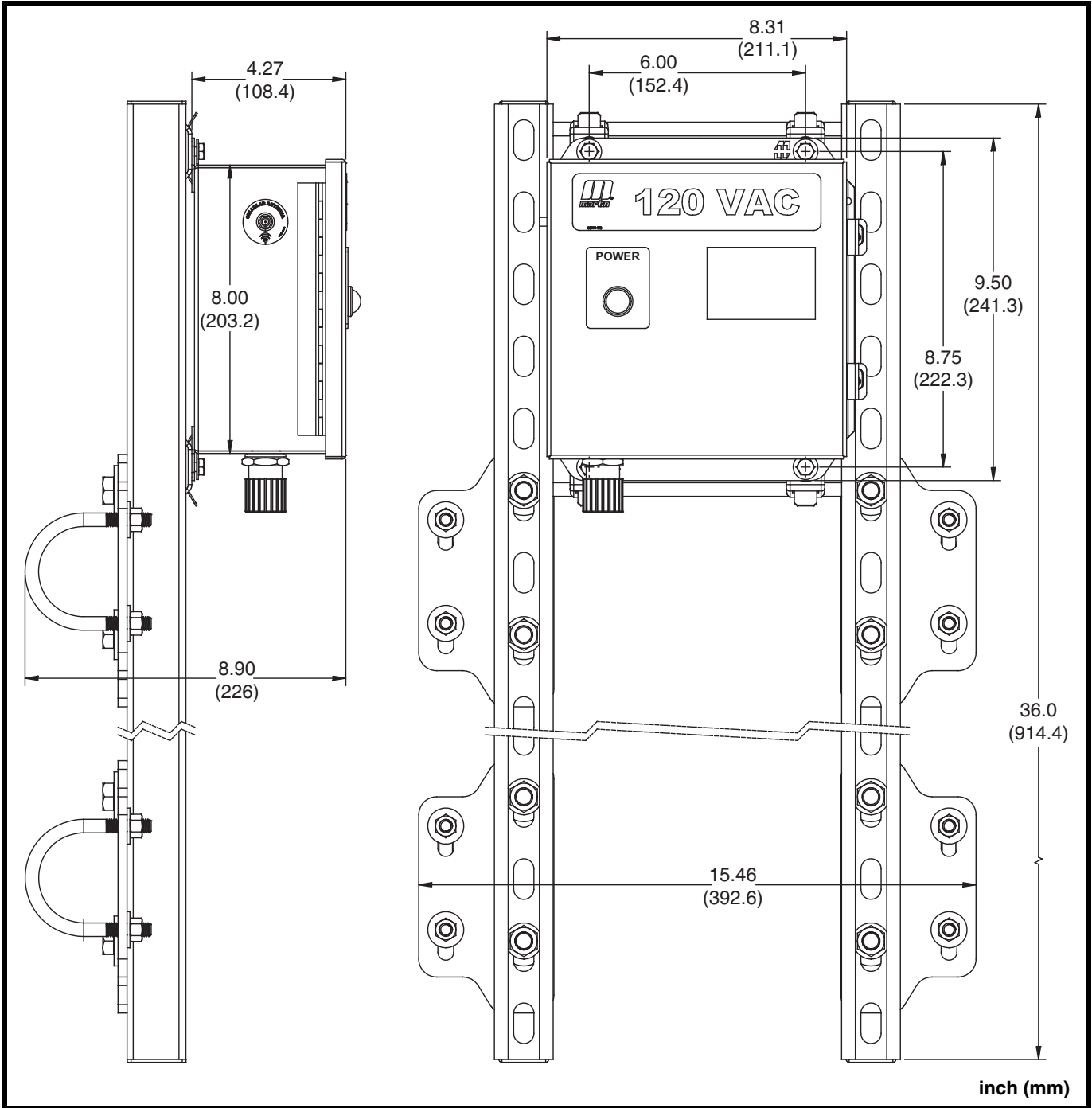
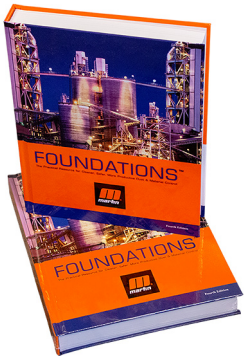

Figure 1. N2<sup>®</sup> Gateway Dimensions

*Any product, process, or technology described here may be the subject of intellectual property rights reserved by Martin Engineering Company. Trademarks or service marks designated with the ® symbol are registered with the U.S. Patent and Trademark Office and may be proprietary in one or more countries or regions. Other trademarks and service marks belonging to Martin Engineering Company in the United States and/or other countries or regions may be designated with the “TM” and “SM” symbols. Brands, trademarks, and names of other parties, who may or may not be affiliated with, connected to, or endorsed by Martin Engineering Company, are identified wherever possible. Additional information regarding Martin Engineering Company’s intellectual property can be obtained at [www.martin-eng.com/trademarks](http://www.martin-eng.com/trademarks).*

# Problem Solved™ GUARANTEED!



*For nearly 30 years, Martin Engineering's Foundations™ Books have taught industry personnel to operate and maintain clean and safe belt conveyors. The Foundations™ Book, fourth edition, focuses on improving belt conveyors by controlling fugitive material. "The Practical Resource for Total Dust and Material Control," is a 576-page hard cover volume that provides information of value to industries where the efficient handling of bulk materials is a key to productivity and profitability.*

*Expanding upon the book, our Foundations™ Training Program addresses the design and development of more productive belt conveyors, and is offered in three customizable seminars. Attendees gain a better understanding of conveyor safety and performance, helping to justify upgrade investments and increase profitability.*



**Martin Engineering Australia Pty Ltd.**  
102 Christensen Road South  
Stapylton QLD 4207 - Australia  
+61 1300 627 364  
salesau@martin-eng.com | www.martin-eng.com.au

